



WirelessONE™ EZ Mount™

Kit Number
25980EZ

EZ Mount Compressor System

Introduction

WirelessONE EZ Mount combines a manifold and compressor into a single, easy-to-install unit, along with wiring harness and accessories needed to connect to vehicle power and air springs (purchased separately).

It is important to read and understand the entire installation guide before beginning installation or performing any maintenance, service or repair. The information here includes a hardware list, step-by-step installation information and safety information.

USING THE SYSTEM

Refer to the WirelessONE User Guide included with this kit to learn how to operate the system.

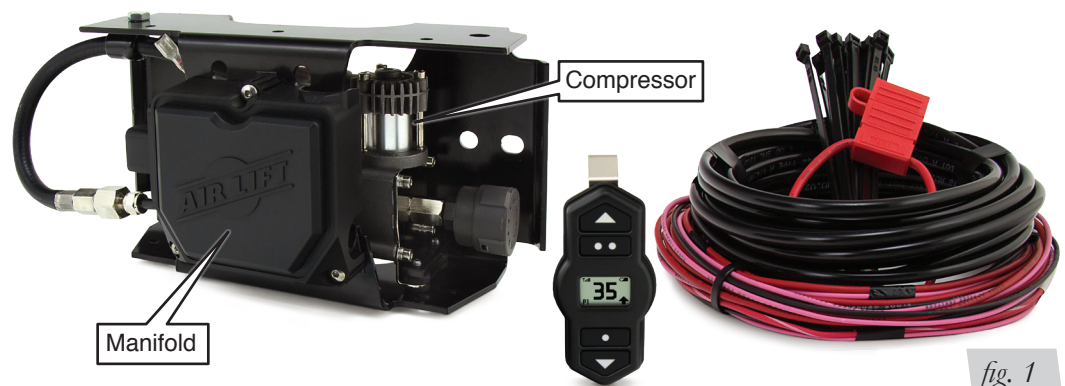

NOTATION EXPLANATION

Hazard notations highlight information that must be observed to help minimize risk of personal injury or possible improper installation, which may render the vehicle unsafe.

⚠ DANGER

INDICATES IMMEDIATE HAZARDS WHICH WILL RESULT IN SEVERE PERSONAL INJURY OR DEATH.

⚠ WARNING

INDICATES HAZARDS OR UNSAFE PRACTICES WHICH COULD RESULT IN SEVERE PERSONAL INJURY OR DEATH.

⚠ CAUTION

INDICATES HAZARDS OR UNSAFE PRACTICES WHICH COULD RESULT IN DAMAGE TO THE MACHINE OR MINOR PERSONAL INJURY.

TOOLS LIST

Power drill
1/4", 3/8" Drill bits
Grinder
3/8", 1/2", 5/16", 9/16" Sockets and ratchet
Wire stripping/crimping tool
Sharp razor knife

HARDWARE LIST

Item	Part #	Description.....	Qty
A	72709	Wireless controller	1
B	26562	EZ Mount assembly	1
C	20946	Air line (1/4")	20 ft.
D	26896	Wiring harness	1
E	21838	Tee 1/4" PTC	2
F	24652	ATC fuse, spade 15A	1
G	24752	Heat shrink butt splice 12-10 ga	2
H	24500	Fuse holder ATC/ATO	1
I	10466	8" Zip tie	18
J	24748	3/8" Ring terminal	2
K	11104	U-bolt.....	1
L	18435	3/8"-16 Nylon locking nut.....	2
M	18444	3/8" Flat washer.....	4
N	17188	3/8"-16 x 1 1/4" Hex cap bolt.....	2
O	17102	5/16"-18 x 3/4" Self-tapping hex screw	2
P	10868	Tree mount.....	3
Q	17173	#14-1/4 x 3/4" Self-tapping hex screw.....	1

Installing WirelessONE EZ Mount

1. There are three choices for mounting: 1) hex cap bolts (N) with flat washers (M) and nylon lock nuts (L); 2) U-bolt (K) with washers (M) and nylon lock nuts (L); 3) self-tapping screws (O).

2. EZ Mount can be mounted in any orientation except with the electrical connector pointed down or with the Air Lift logo facing the ground (Fig. 5). There are mounting holes in the side of the bracket and in the top. Use the included template for mounting with self-tapping screws or hex cap bolts. If mounting from the top, you must first remove the P-clamp and then re-install the P-clamp using the mounting hardware. Use a 1/4" drill bit to make pilot holes if using self-

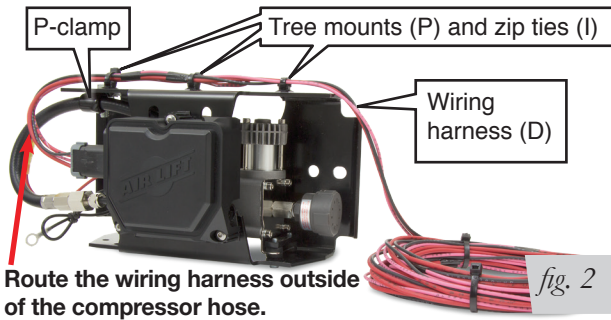

tapping screws. Before drilling, ensure that the back side is clear of vehicle components including brake lines, fuel lines, wiring, etc. Do not remove components from the EZ Mount assembly.

3. Attach the wiring harness to the top (preferred) or bottom of the EZ Mount bracket with tree mounts (P) and zip ties (I) (Fig. 2).

4. Connect the compressor ground wire to the frame using the small self-tapper (Q). The ground must have a good connection to the frame. It may be necessary to grind some paint or rust off the frame to make good contact.

5. Cut off the terminal on the red compressor wire before connecting to the wiring harness (D). Route the wiring harness along the frame and make all wiring and air line connections. Finish by connecting the wiring to the battery. Install the fuse (F) last.



U-bolt installation

Wiring to the battery

CAUTION
INSTALL THE FUSE AFTER ALL CONNECTIONS ARE MADE.

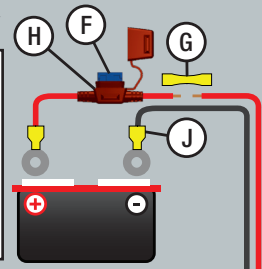

OPTIONAL Ignition Source Connection

Connect the pink wire to any wire that is active when the ignition is on. This will allow WirelessONE to make adjustments as soon as the ignition is turned on. Otherwise, the system will only activate when the vehicle moves or when woken up by the controller or mobile app. Hardware to connect to the ignition is not included. This is a low-amperage circuit that should be connected to the output side of a 10A or smaller fuse-protected circuit.

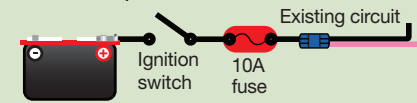

EZ Mount (Manifold & Compressor)

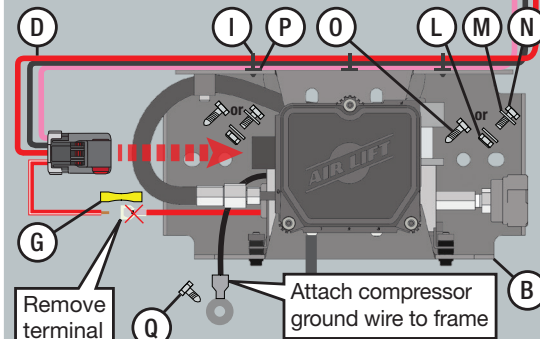

Hex cap bolt torque
21-25 lb.-ft. (30-34Nm)

U-bolt torque
4-6 lb.-ft. (5.4-8.1Nm)

Self-tapping screw torque
No torque spec is provided for self-tapping screws because there are too many variables.

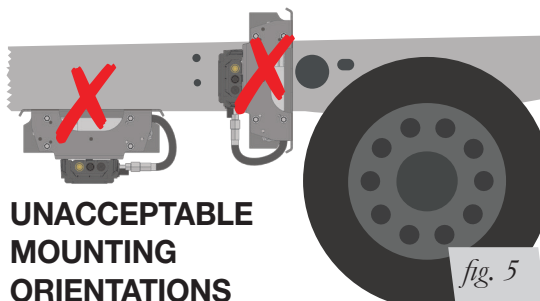
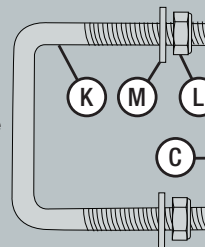

UNACCEPTABLE MOUNTING ORIENTATIONS

fig. 5

SUGGESTED COMPONENT LAYOUT

This guide should be used as a general reference. The layout may need modification based on the application.

- Ideally, EZ Mount should be mounted in the middle of the vehicle in the zone marked by the yellow square to optimize the wireless performance. If necessary, the EZ Mount can be mounted farther back, but must be mounted forward of the rear axle.
- Avoid routing air lines and wiring near sharp edges. If passing air lines or wiring through holes in the frame, use rubber grommets. Support wiring and air lines every 8-12" (200-300mm) with zip ties or other means.
- Keep wiring and air lines and EZ Mount at least 6" away from heat sources such as the exhaust.

To keep voltage drop within industry standards, do not extend wires. Extending the wires could decrease compressor life.

The frame width for using the U-bolt must be 2 1/4"-3 3/4" (57-95mm). Frame height must be 7 1/2"-8 1/2" (191-216mm).

Optimum location for EZ Mount

fig. 4

Schrader valve, air line, elbow fittings, air springs and associated hardware included with air spring kit. Air spring kits are sold separately.

CUTTING AIR LINES

Use a sharp knife or a hose cutter and make clean, square cuts. Do not use scissors or wire cutters because these tools will deform the air line. Do not cut the lines at an angle.

The minimum bend radius for 1/4" air line is 1" (25mm). Air lines are to be installed straight into fittings.

Inspect the air line for scratches that run lengthwise. Contact Air Lift customer service if the air line is damaged.

 To watch a video demonstrating proper air line cutting, go to air-lift.co/cuttingairline.



CAUTION

DO NOT MOUNT EZ MOUNT WITH THE WIRING HARNESS CONNECTOR OR AIR LIFT LOGO POINTED DOWN (FIG. 5).

DO NOT HANG EZ MOUNT FROM A HORIZONTAL SURFACE USING SELF-TAPPING SCREWS.

PLACE THE COMPONENTS AND ROUTE THE AIR LINES AND WIRING HARNESS TO AVOID HEAT SOURCES SUCH AS THE EXHAUST SYSTEM.

PROTECT AIR LINES AND WIRING WHEN ROUTING NEAR SHARP EDGES.

LOCATE EZ MOUNT IN AN AREA OF THE VEHICLE WHERE IT WILL BE SHIELDED FROM DIRECT SPLASH. EXCESSIVE MOISTURE CAN DAMAGE THE COMPRESSOR AND CAUSE SYSTEM FAILURE.

REMOVE ALL FUSES WHEN JUMP-STARTING OR WELDING ON THE VEHICLE. FAILURE TO DO SO COULD DAMAGE THE MANIFOLD.

Need Help?

Contact Air Lift Company customer service department by calling (800) 248-0892.

For calls from outside the USA or Canada, dial (517) 322-2144.



Thank you for purchasing Air Lift products — the professional installer's choice!

Air Lift Company reserves the right to make changes and improvements to its products and publications at any time. For the latest version of this manual, contact Air Lift Company at **(800) 248-0892** or visit www.airliftcompany.com.

Air Lift Company • 2727 Snow Road • Lansing, MI 48917 or P.O. Box 80167 • Lansing, MI 48908-0167
Toll Free (800) 248-0892 • Local (517) 322-2144 • Fax (517) 322-0240 • www.airliftcompany.com

Printed in the USA
JJC-0618

California: ⚠️WARNING: Cancer and Reproductive Harm - www.P65Warnings.ca.gov

DRILLING TEMPLATE VERIFICATION

CAUTION

IMPORTANT: PRINT THIS PAGE AT 100% SCALE. THIS IS A DRILLING TEMPLATE, WHICH WOULD BE RENDERED INCORRECT IN DIMENSION IF PRINTED WITH ANY SCALING. USING AN INCORRECT TEMPLATE TO DRILL HOLES MAY CAUSE

DAMAGE TO THE VEHICLE! PLEASE REFER TO THE ONE-INCH OR 1CM SCALES AND USE A MEASURING TOOL TO CONFIRM THAT THE PRINTED SCALE MEASURES 1" OR 1CM TO VERIFY THAT THE TEMPLATE HAS BEEN PRINTED AT 100% SCALE.



SIDE

TOP

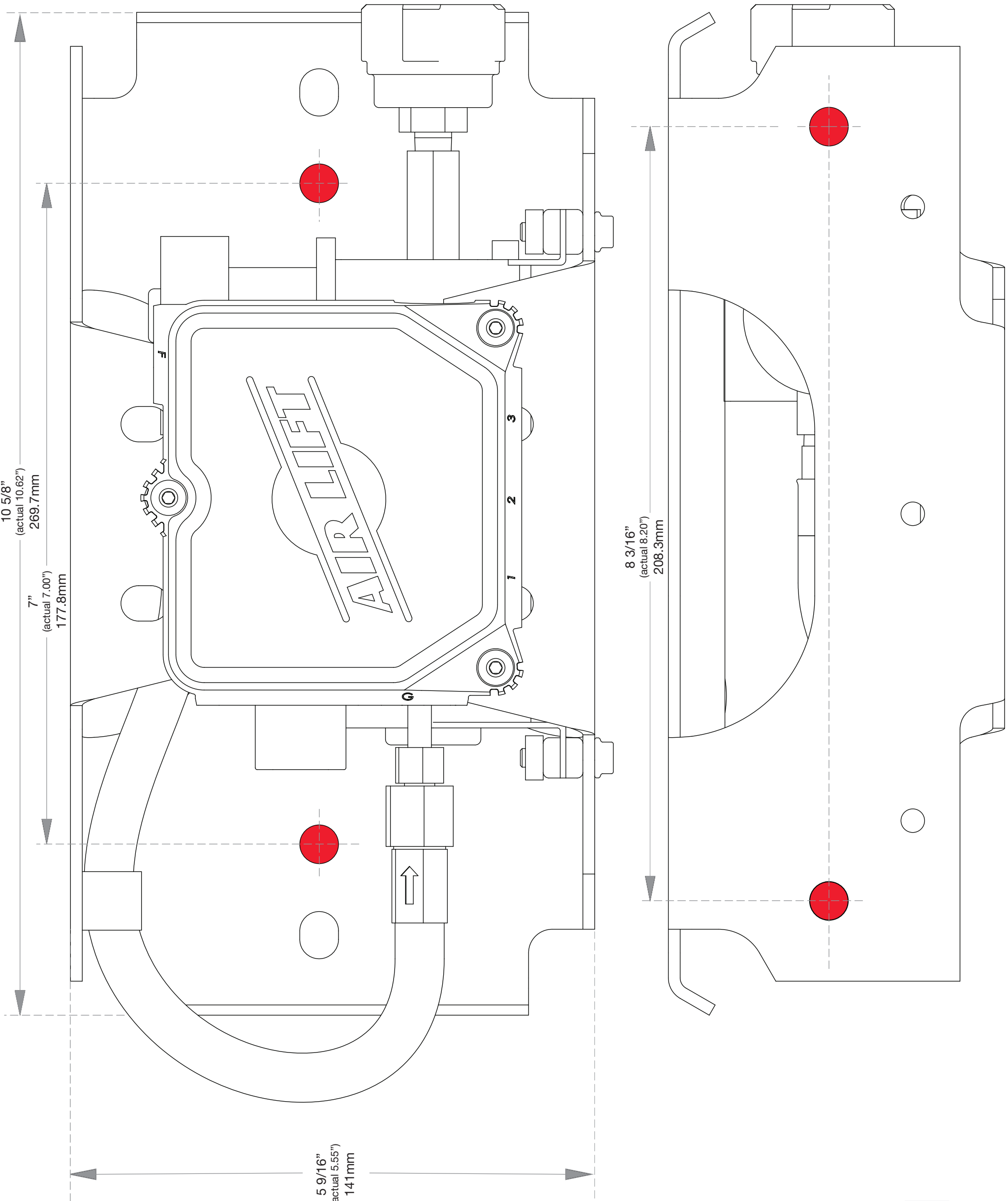

* Fractional measurements are approximate.

fig. 6