



INSTALLATION INSTRUCTIONS



MUFFLER xMOD 5x8x18 3.0/3.0 | PART NO. 14009

BILL OF MATERIALS:

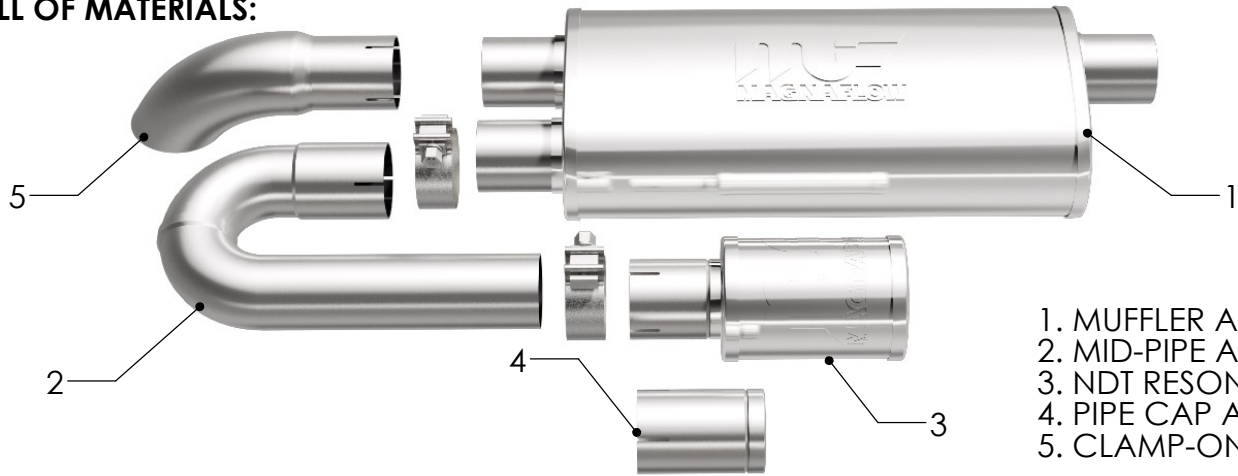

- 1. MUFFLER ASSY
- 2. MID-PIPE ASSY
- 3. NDT RESONATOR
- 4. PIPE CAP ASSY
- 5. CLAMP-ON TIP



WEAR SAFETY GLASSES



READ INSTRUCTIONS THOROUGHLY BEFORE INSTALLING PRODUCT



SPRAY LUBRICANT

To ease removal of existing exhaust components (especially on older vehicles) spray penetrating lubricant on all fasteners and hangers/insulators that will be loosened or removed and let soak before disassembly.

HARDWARE KIT:

- 1. [2] 2.50" Clamp

MINIMUM REQUIRED TOOLS:



Saw (Or Other Cutting Tool)



15 mm



Hanger Tool (Or Pry Bar)

MAGNAFLOW RECOMMENDS PROFESSIONAL INSTALLATION ON ALL THEIR PRODUCTS



WARNING: When working on, under, or around any vehicle exercise caution. Please allow the vehicle's exhaust system to cool before removal, as exhaust system temperatures may cause severe burns. If working without a lift always consult vehicle manual for correct lifting specifications. Always wear safety glasses and ensure a safe work area. Serious injury or death could occur if safety measures are not followed.

ATTENTION: Always install any supplied band or U-bolt clamps to the proper torque specifications of 40-45 ft-lb for band clamps and 30-35 ft-lb for U-bolt clamps. Over tightening will result in the clamps breaking and will NOT be warranted by MagnaFlow.

MAGNAFLOW: 1901 Corporate Centre Dr - Oceanside, CA 92056 | 1(800)990-0905
Technical Support: 1(800) 959-9226 | Email: moreinfo@magnaflow.com

INSTALLATION INSTRUCTIONS

It is necessary to remove your stock muffler to replace it with the xMod universal muffler kit. Select cut points bearing in mind the overall length of the replacement Muffler Assembly. Inlet "A" is to be welded to the OE exhaust outlet after cutting. Outlet "B" is to attach to the cut OE tail pipe or the supplied Clamp-On Tip. Fabrication and welding will be needed to secure the Clamp on Tip to outlet "B".

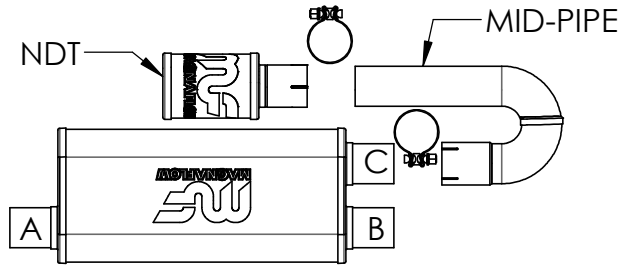

CONFIGURATION # 1

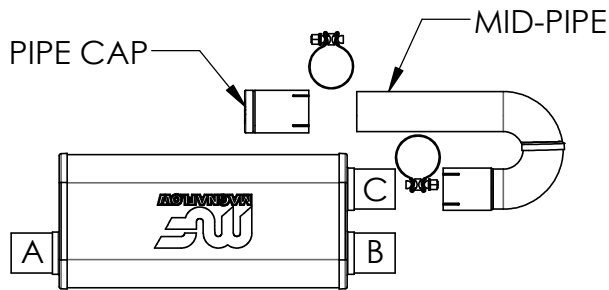

CONFIGURATION # 2

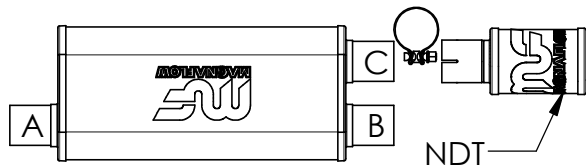

CONFIGURATION # 3

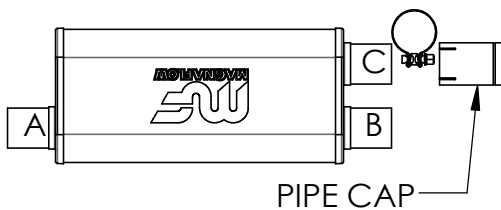

CONFIGURATION # 4

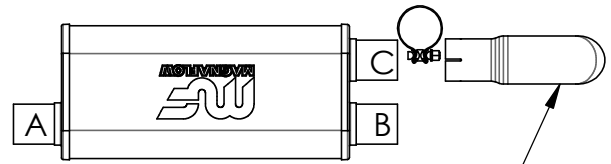

CLAMP-ON TIP

CONFIGURATION # 5

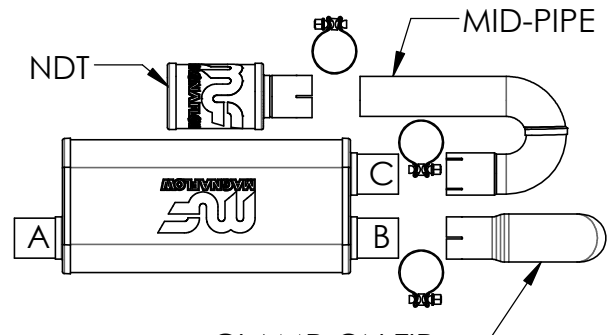

CLAMP-ON TIP

CONFIGURATION # 6

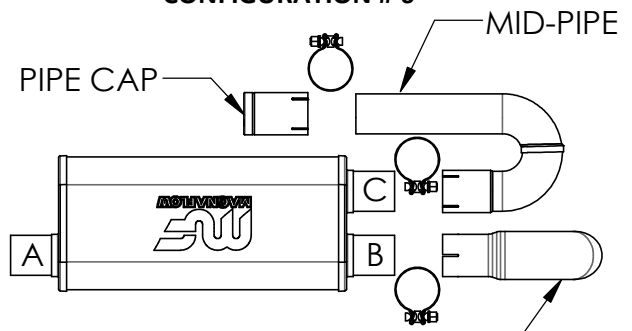

CLAMP-ON TIP

CONFIGURATION # 7

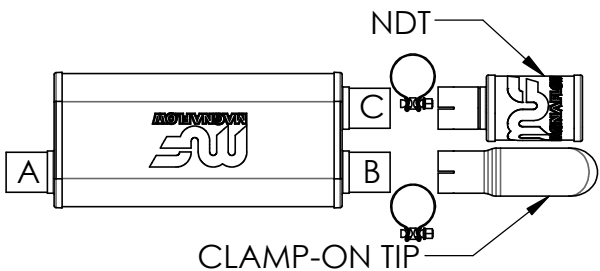

CLAMP-ON TIP

CONFIGURATION # 8

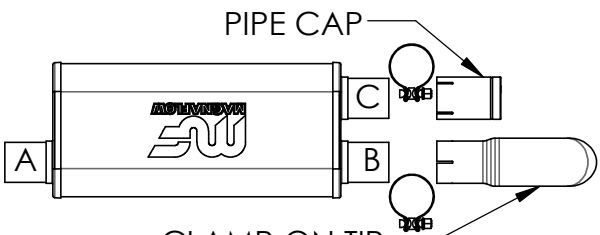

CLAMP-ON TIP

CONFIGURATION # 9

IMPORTANT



Need assistance?

Scan code using your mobile device to visit our help center for instant answers to common questions

Warranty & Returns

For inquiries about warranty and returns, or to start a return, contact MagnaFlow directly:



+1 800 959 9226



moreinfo@magnaflow.com



magnaflow.com/pages/contact-us



magnaflow.com/a/returns



MagnaFlow
3937 Ocean Ranch Blvd
Oceanside, CA 92056

© MagnaFlow is a registered trademark of Car Sound Exhaust System, Inc.
All rights reserved.
ISO 9001:2008 Certified — Registered since 2000

v2021.01_v08.20