



INSTALLATION INSTRUCTIONS



SYSTEM STREET CAT-BACK 5.3L/6.2L

PART NO. 19543

BILL OF MATERIALS:

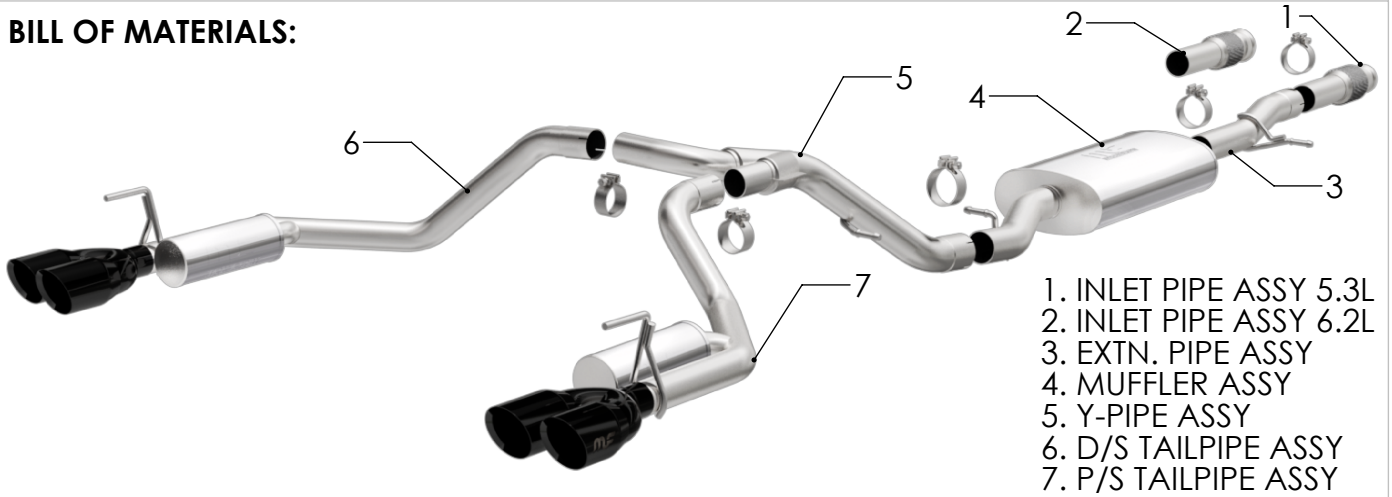

HARDWARE KIT:

1. [3] 3.00" Clamp
2. [2] 2.50" Clamp

SHOP SUPPLIES:



WEAR SAFETY GLASSES



READ INSTRUCTIONS THOROUGHLY BEFORE INSTALLING PRODUCT



SPRAY LUBRICANT

To ease removal of existing exhaust components (especially on older vehicles) spray penetrating lubricant on all fasteners and hangers/insulators that will be loosened or removed and let soak before disassembly.

MINIMUM REQUIRED TOOLS:



15 mm



Hanger Tool (Or Pry Bar)

MAGNAFLOW RECOMMENDS PROFESSIONAL INSTALLATION ON ALL THEIR PRODUCTS



WARNING: When working on, under, or around any vehicle exercise caution. Please allow the vehicle's exhaust system to cool before removal, as exhaust system temperatures may cause severe burns. If working without a lift always consult vehicle manual for correct lifting specifications. Always wear safety glasses and ensure a safe work area. Serious injury or death could occur if safety measures are not followed.

ATTENTION: Always install any supplied band or U-bolt clamps to the proper torque specifications of 40-45 ft-lb for band clamps and 30-35 ft-lb for U-bolt clamps. Over tightening will result in the clamps breaking and will NOT be warranted by MagnaFlow.

MAGNAFLOW: 1901 Corporate Centre Dr - Oceanside, CA 92056 | 1(800)990-0905

Technical Support: 1(800) 959-9226 | Email: moreinfo@magnaflow.com

INSTALLATION INSTRUCTIONS

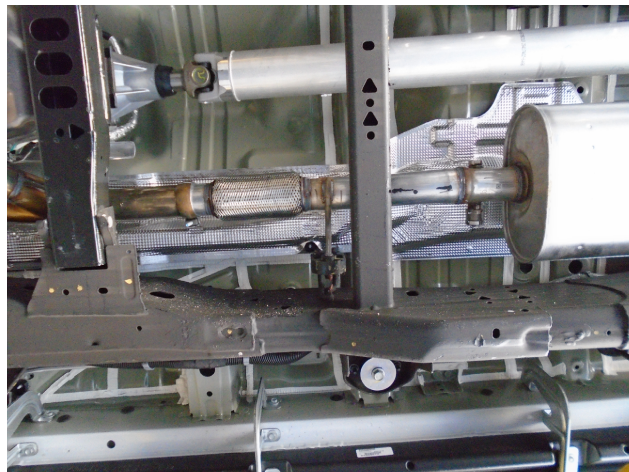

Step 1. To remove the OE exhaust system you will need to remove the spare tire, heat shield and sway bar. Unfasten the clamp attaching the OE inlet pipe assembly to the catalytic converter. Do not damage or discard the inlet pipe clamp or rubber insulators as they will be re-used to mount the new system. Working front to rear disengage the hangers from their rubber insulators and remove the exhaust from the vehicle.

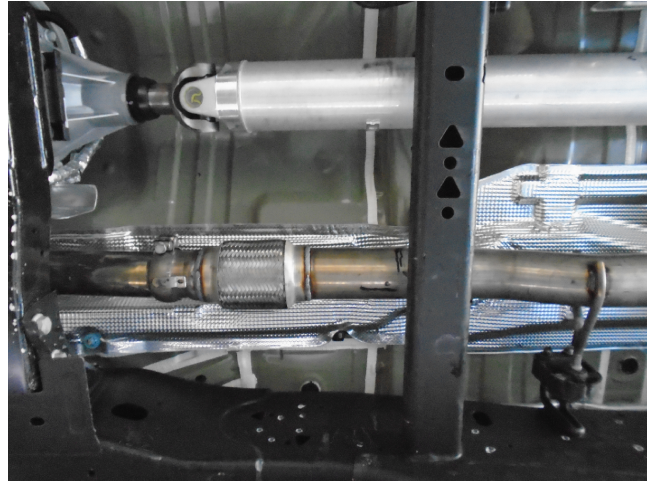

Step 2. There are two inlet pipe assemblies supplied in this kit to accommodate the 5.3 and 6.2L engines. Select the appropriate inlet for your engine configuration. The assembly with the larger inlet flare will be for the 6.2L engine. Begin the install by fastening the Inlet Pipe Assembly to the outlet of the OE system using the OE clamp (Leave all clamps and fasteners loose for final adjustment of the complete system.)

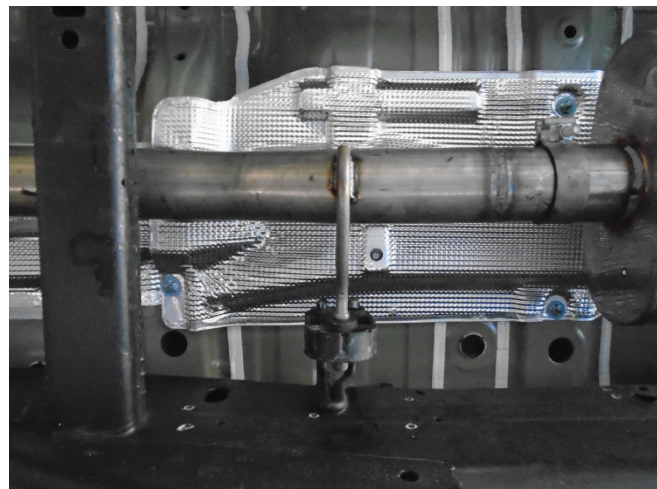

Step 3. Attach the Extension Pipe Assembly to the Inlet Pipe Assembly with a supplied 3.00" clamp. Engage the welded hanger to the rubber insulator.

INSTALLATION INSTRUCTIONS

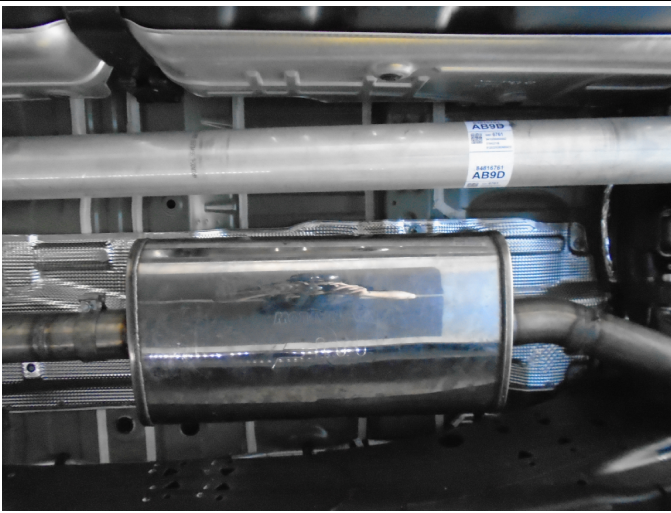

Step 4. Loosely attach the Muffler Assembly to the Extension Pipe Assembly with a supplied 3.00" clamp. Engage the welded hanger to the rubber insulator.

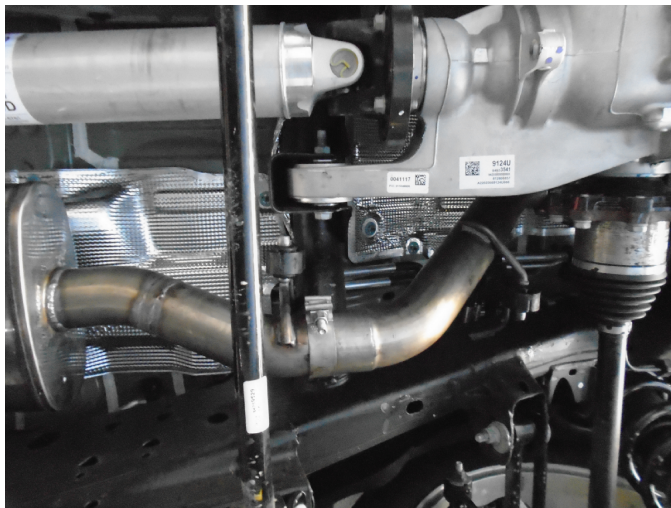

Step 5. Next loosely attach the Y-Pipe Assembly to the Muffler Assembly using the supplied clamp. Engage the welded hangers to the rubber insulators.

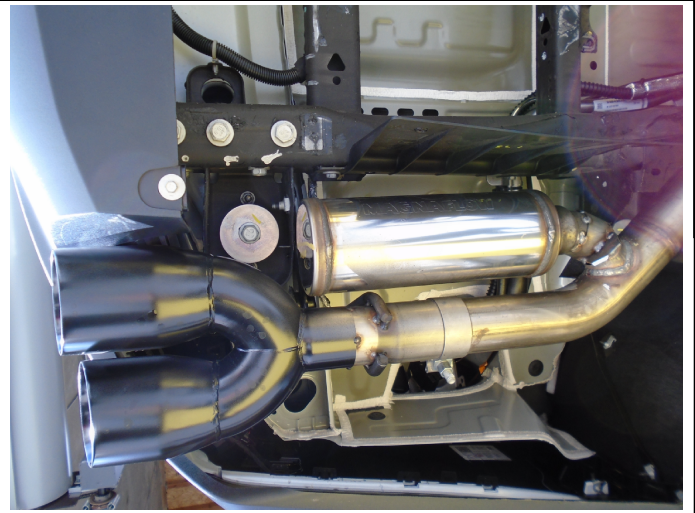
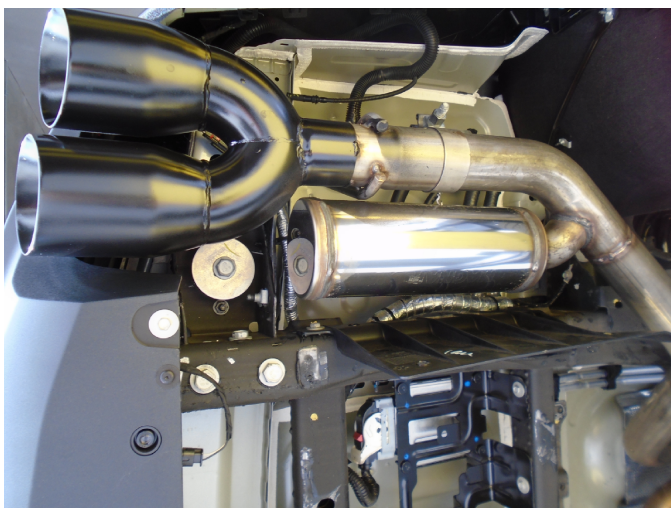

Step 6. Complete the installation by attaching both Tailpipe Assemblies to the Y-Pipe Assembly using the Supplied 2.50" clamps and engaging the welded hangers to the rubber insulators.



Step 7. Once a final position has been chosen for the new exhaust system, evenly tighten all clamps from front to rear using the torque specifications on page one of the instructions. Inspect all fasteners after 25-50 miles of operation and re-tighten if necessary.