

2004 PONTIAC GTO 5.7L V8

Warning: When working on, under, or around any vehicle exercise caution. Please allow the vehicle's exhaust system to cool before removal, as exhaust system temperatures may cause severe burns. If working without a lift, always consult vehicle manual for correct lifting specifications. Always wear safety glasses and ensure a safe work area. Serious injury or death could occur if safety measures are not followed.

Step 1: (Carefully read all instructions before installation) Disconnect the vehicle's battery before removal of the OEM exhaust system. This will allow the computer to reset itself with the new exhaust system, and prevent electrical accidents. Begin removing the OEM exhaust system by unbolting the fasteners at the 2-bolt flanges behind the catalytic converters. Do not discard or damage the OEM fasteners and rubber insulators, as they will be reused to mount the new exhaust system. Loosen the two clamps located behind the mufflers, disengage the welded hangers from the rubber insulators and remove the tailpipe assembly. Remove the OEM muffler assembly by disengaging the welded hangers from the rubber insulators as well.

Step 2: Mount the new exhaust system using a front to rear pattern. Using the OEM fasteners, install the muffler assembly at the 2-bolt flanges and insert the welded hangers into the OEM rubber insulators. Leave all clamps and fasteners loose for final adjustment of the new exhaust system. Using the supplied 2.50" clamps, install the driver's and passenger's side extension pipes. Install the tailpipe assembly in a similar fashion.

Step 3: With all components mounted loosely, adjust the system for overall aesthetics and clearance of frame & bodywork. (MAGNAFLOW recommends at least 1/2" of clearance between the exhaust system and any body panels to prevent heat-related body damage or fire.)

Step 4: Once a final position has been chosen for the new system, evenly tighten all fasteners from front to rear. The supplied band clamps must be VERY tight to properly align the pipes and prevent leaks (Approximately 40ft-lbs). Inspect all fasteners after 25-50 miles of operation and retighten if necessary.

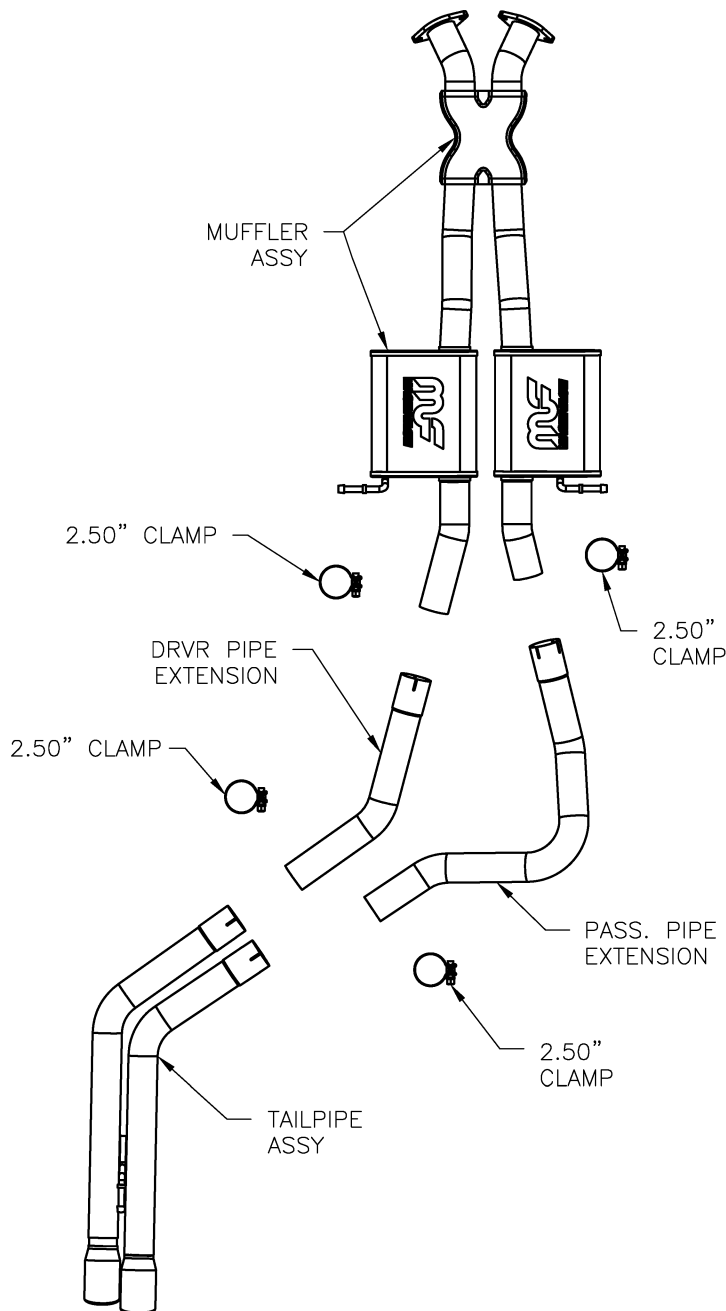

*MAGNAFLOW Performance Exhaust recommends professional installation on all their products

Technical support: 1-800-959-9226 ext. 4500