



INSTALLATION INSTRUCTIONS



2019 FORD MUSTANG GT 5.0L | PART NO. 19535

BILL OF MATERIALS:

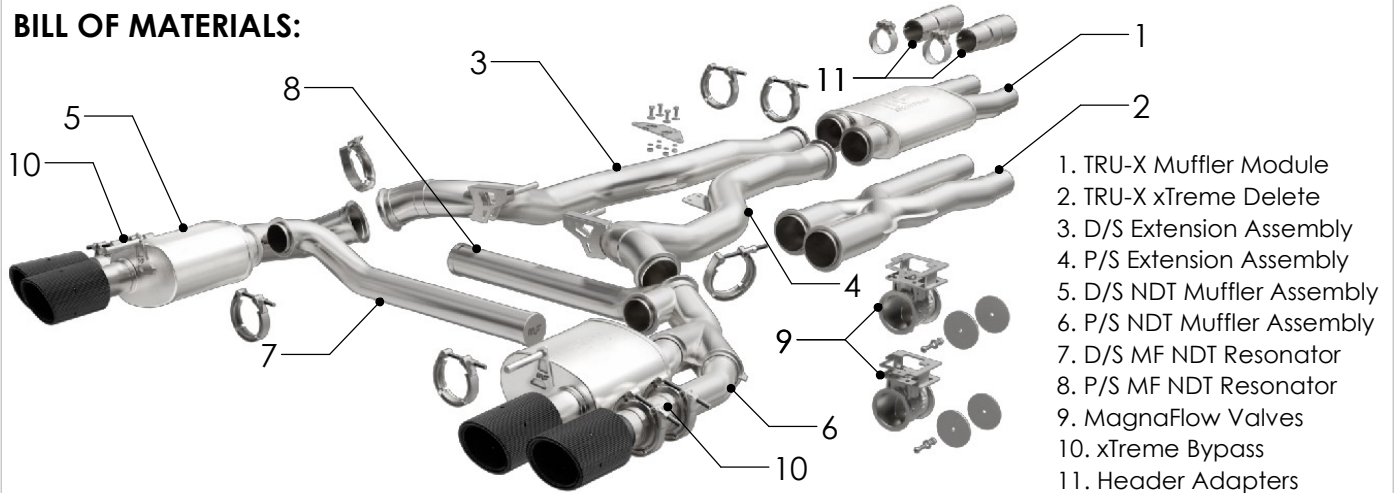

SHOP SUPPLIES:



WEAR SAFETY GLASSES



READ INSTRUCTIONS THOROUGHLY BEFORE INSTALLING PRODUCT



SPRAY LUBRICANT

To ease removal of existing exhaust components (especially on older vehicles) spray penetrating lubricant on all fasteners and hangers/insulators that will be loosened or removed and let soak before disassembly.

HARDWARE KIT:

- 1.[6] 3.00" V-Clamp
- 2.[4] 2.50" V-Clamp
- 3.[1] MF Bracket
- 4.[6] M6 Bolt
- 5.[6] M6 Nut
- 6.[6] M6 Lock Washer
- 7.[6] M6 Flat Washer
- 8.[2] xTreme Bypass Block-Off w/ Gaskets
- 9.[2]Header Adapter Pipes
- 10.[2] 2.50" Torca Clamps

MINIMUM REQUIRED TOOLS:



11mm, 13mm, 15 mm, 7/16"



Hanger Tool (Or Pry Bar)

MAGNAFLOW RECOMMENDS PROFESSIONAL INSTALLATION ON ALL THEIR PRODUCTS



WARNING: When working on, under, or around any vehicle exercise caution. Please allow the vehicle's exhaust system to cool before removal, as exhaust system temperatures may cause severe burns. If working without a lift always consult vehicle manual for correct lifting specifications. Always wear safety glasses and ensure a safe work area. Serious injury or death could occur if safety measures are not followed.

ATTENTION: Always install any supplied band or U-bolt clamps to the proper torque specifications of 40-45 ft-lb for band clamps and 30-35 ft-lb for U-bolt clamps. Over tightening will result in the clamps breaking and will NOT be warranted by MagnaFlow.

MAGNAFLOW: 1901 Corporate Centre Dr - Oceanside, CA 92056 | 1(800)990-0905
Technical Support: 1(800) 959-9226 | Email: moreinfo@magnaflow.com

INSTALLATION INSTRUCTIONS



NOTICE BEFORE INSTALLATION:

The Ford Mustang can be purchased with an "Active Exhaust" system including exhaust valves (image above). This MagnaFlow kit can be used with "Active Exhaust" by using the provided MagnaFlow valves.

Step 1 and Step 3 are for vehicles equipped with Active Exhaust, skip these steps if your vehicle is not equipped with Active Exhaust

Step 4 is for applications with aftermarket headers. Please note that depending on the manufacturer of the headers, header connection pipe may require modification to fit as each exhaust manufacturer may have unique profiles.

Step 1. To remove the OEM system first unplug the electrical connector at the exhaust valves.

Step 2. Begin by loosening the clamps at the exhaust inlet. Remove all four welded hangers from the rubber insulators and remove the exhaust. Do not damage the fasteners or rubber insulators as they will be used to install the new MagnaFlow system.

Step 3. Once the exhaust is off of the vehicle remove the valve motors from the muffler assembly and transfer it over to the new MagnaFlow exhaust valve assembly using the factory hardware.

INSTALLATION INSTRUCTIONS

Step 4. (OPTIONAL) If installing on a vehicle with aftermarket headers, modifying the Extreme Delete Tru-x and Tru-x Muffler module will be required to accommodate header pipe connection. First cut the reduced section of pipe off of the inlet pipes on the Extreme Delete Tru-x and Tru-x Muffler module. Then attach the header adapter pipes with the supplied 2.50" torca clamps. The modules will now have a 3.00" interior diameter to accommodate 3.00" aftermarket headers. Depending on the various header applications modifications may be required.

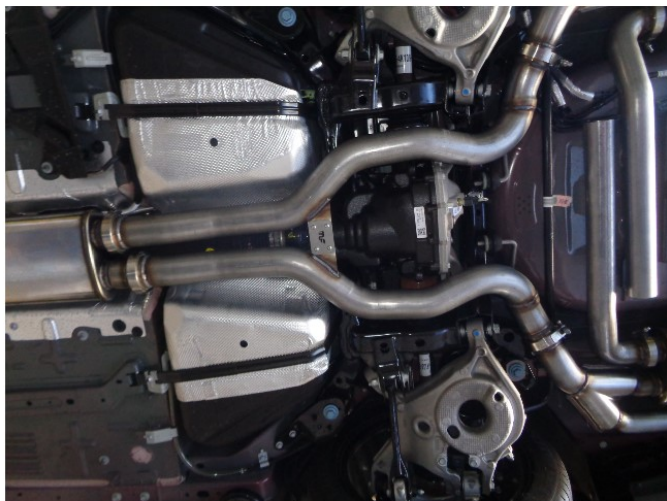
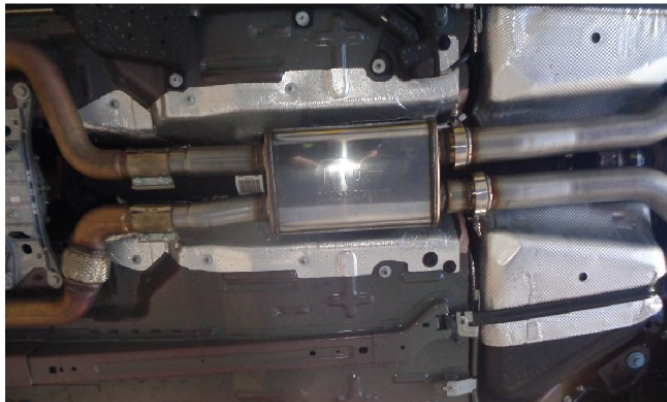

Step 5. MagnaFlow xMOD exhausts are designed with multiple build options giving the ability to use different components depending on sound and performance preference (See Page 5 and 6).

Begin installation of the MagnaFlow system by attaching either the TRU-X xTreme Delete or the TRU-X Muffler Module to the OE Converter outlet pipes using the OE clamps. Next, attach the Extension Assemblies using two of the supplied V clamps and engaging the hangers into the rubber insulators. (Leave all clamps and fasteners loose for final adjustment of the complete system.)

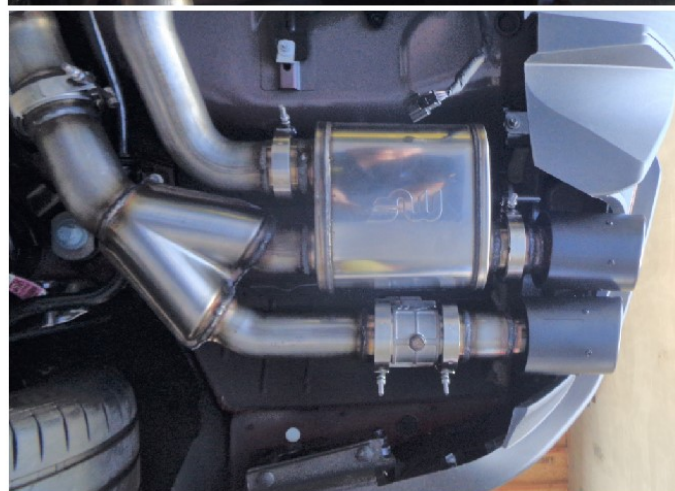

Step 6. The NDT Muffler assemblies are shipped with the xTreme Bypass modules installed without the xTreme Bypass Block-Off Plates. Depending on preference, there are four different exhaust configurations possible with this system in either non-Active Exhaust (See Page 5) or Active Exhaust configurations (See Page 6).

Determine the best configuration for your preference. If using xTreme Bypass / Block-Off open no modifications are needed. If using MagnaFlow Valves remove the xTreme Bypass from the NDT Muffler Assemblies by loosening the V clamps and loosely installing Valve Assemblies. If using the xTreme Bypass / Block-Off closed loosen the front V clamp of xTreme Bypass and insert Block-Off Plate to counter bore of flange then loosely tighten. For every configuration make sure the flanges are aligned straight and do final tightening of V clamps when mufflers are installed on vehicle for proper tip alignment.

MAGNAFLOW: 1901 Corporate Centre Dr - Oceanside, CA 92056 | 1(800)990-0905

Technical Support: 1(800) 959-9226 | Email: moreinfo@magnaflow.com



Step 7. Next install the passenger side NDT Muffler Assembly followed by the driver side NDT Muffler Assembly using supplied V clamps and engaging the hangers into the rubber insulators. Then install each of the NDT Resonators to the NDT Muffler Assemblies by attaching to V clamps and rotating so they are level or horizontal to the ground. It is critical that the NDT Resonators are not in close proximity to moving suspension, plastics, or electronics as they can get extremely hot. Finish the installation by loosely attaching the MagnaFlow bracket between the Extension Pipes. Re-attach the valve wiring if using the MagnaFlow Valves and make sure they are secured properly away from the heat of the mufflers.



Step 8. Once a final position has been chosen for the new exhaust system, evenly tighten all clamps and fasteners, from front to rear, using the torque specifications on page one of the instructions. Inspect all fasteners after 25-50 miles of operation and re-tighten if necessary.

xMOD™ Series Configurations

FORD MUSTANG *without Active Exhaust*

xMOD™ is a revolutionary, fully modular performance exhaust system. Personalize and fine tune your Mustang's exhaust system to configure the power and sound you want when you want it with the simple swap of a few modules.

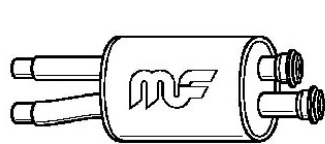

Tru-X™ Muffler Module

+



xTreme Bypass
(Closed)

=



Stealth

Smooth-tuned note crafted for maximum sound suppression, while supporting more airflow for additional power-adders.

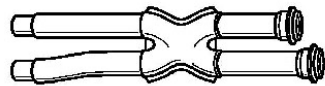

Tru-X™ xTreme Delete

+



xTreme Bypass
(Closed)

=



Street

Aggressive and throaty growl mixed with chambered exhaust tones for a street performance sound.



Tru-X™ Muffler Module

+



xTreme Bypass
(Open)

=



Competition

Rich. Deep. Powerful. The distinctive MagnaFlow performance tone designed for balanced street performance.

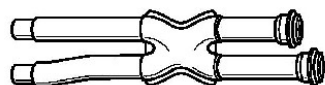

Tru-X™ xTreme Delete

+



xTreme Bypass
(Open)

=



Race

Straight-pipe sounds inside and out, with the rasp and pop reminiscent of chambered exhausts.

xMOD™ Series Configurations

FORD MUSTANG *with Active Exhaust*

xMOD™ is a revolutionary, fully modular performance exhaust system designed to work with the factory electronic controlled valves. Personalize and fine tune your Mustang's exhaust system to configure the power and sound you want when you want it by swapping modules and using menu-driven Active Exhaust modes.



Tru-X™ Muffler Module

+

QUIET
NORMAL
SPORT
TRACK

=



Stealth

Active Exhaust
(Select either menu mode)

Smooth-tuned note crafted for maximum sound suppression, while supporting more airflow for additional power-adders.

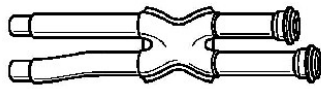

Tru-X™ xTreme Delete

+

QUIET
NORMAL
SPORT
TRACK

=



Street

Active Exhaust
(Select either menu mode)

Aggressive and throaty growl mixed with chambered exhaust tones for a street performance sound.



Tru-X™ Muffler Module

+

QUIET
NORMAL
SPORT
TRACK

=



Competition

Active Exhaust
(Select either menu mode)

Rich, Deep, Powerful. The distinctive MagnaFlow performance tone designed for balanced street performance.

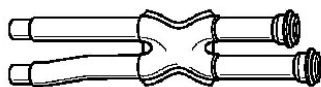

Tru-X™ xTreme Delete

+

QUIET
NORMAL
SPORT
TRACK

=



Race

Active Exhaust
(Select either menu mode)

Straight-pipe sounds inside and out, with the rasp and pop reminiscent of chambered exhausts.