



# INSTALLATION INSTRUCTIONS



1999-2003 FORD F-250/F-350 7.3L | PART NO. 17879

### BILL OF MATERIALS:

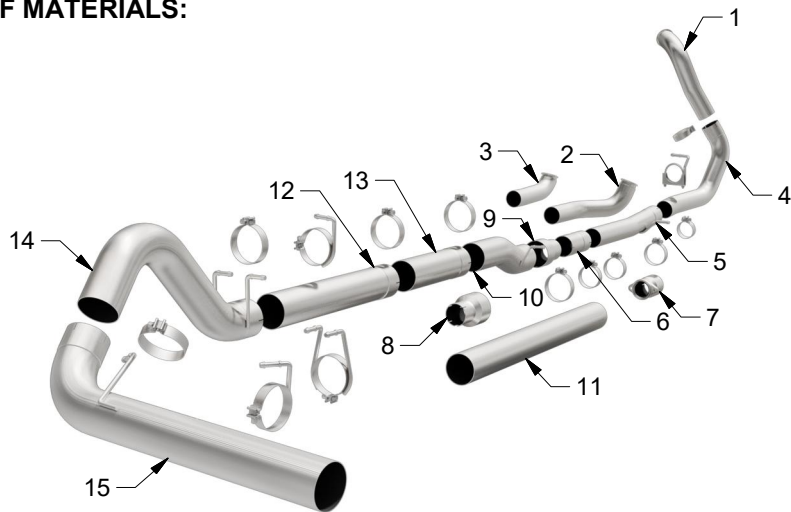

1. INLET PIPE ASSY.
2. INLET PIPE ASSY.
3. INLET PIPE ASSY.
4. INLET PIPE LOWER ASSY
5. INLET EXTN PIPE ASSY
6. EXTN PIPE 4.00x9.00"
7. PIPE/FLANGE ASSY.
8. ADAPTER 3.50/5.00x7.00"
9. ADAPTER 4.00/5.00x7.00"
10. MID EXTN PIPE ASSY
11. EXTN PIPE 5.00x51.00"
12. EXTN PIPE 5.00x30.00"
13. EXTN PIPE 5.00x18.00"
14. OVER AXLE PIPE ASSY.
15. TAIL PIPE ASSY.



WEAR SAFETY GLASSES



READ INSTRUCTIONS THOROUGHLY BEFORE INSTALLING PRODUCT

### SHOP SUPPLIES:



SPRAY LUBRICANT

To ease removal of existing exhaust components (especially on older vehicles) spray penetrating lubricant on all fasteners and hangers/insulators that will be loosened or removed and let soak before disassembly.

### HARDWARE KIT:

1. [1] 3.50" Clamp
2. [3] 4.00" Clamp
3. [5] 5.00" Clamp
4. [1] Hanger Clamp #1
5. [1] Hanger Clamp #2
6. [1] Hanger Clamp #3
7. [1] Hanger Clamp #4
8. [1] 4.00" U-Bolt
9. [2] Nut Hex 3/18"

### MINIMUM REQUIRED TOOLS:



15mm



Hanger Tool (Or Pry Bar)



Cutting Device

### MAGNAFLOW RECOMMENDS PROFESSIONAL INSTALLATION ON ALL THEIR PRODUCTS



**WARNING:** When working on, under, or around any vehicle exercise caution. Please allow the vehicle's exhaust system to cool before removal, as exhaust system temperatures may cause severe burns. If working without a lift always consult vehicle manual for correct lifting specifications. Always wear safety glasses and ensure a safe work area. Serious injury or death could occur if safety measures are not followed.

**ATTENTION:** Always install any supplied band or U-bolt clamps to the proper torque specifications of 40-45 ft-lbs for band clamps and 30-35 ft-lbs for U-bolt clamps. Over tightening will result in the clamp breaking and will NOT be warranted by MagnaFlow.

# INSTALLATION INSTRUCTIONS

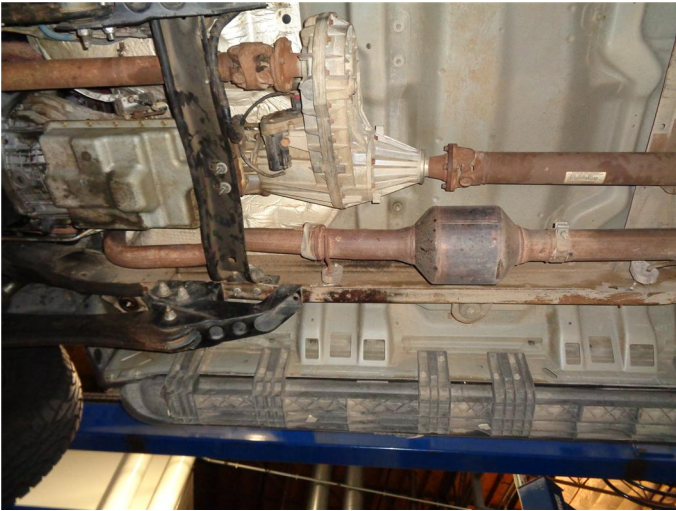

**Step 1.** Working front to rear loosen or remove all OEM band clamps and disengage all welded hangers from the rubber insulators. Be sure to retain all mounting hardware as it will be needed to install your new MAGNAFLOW system.



**Step 2.** Install the corresponding Inlet Pipe Assembly and loosely fasten it to the turbo charger outlet using the OEM clamp. Next, loosely attach the Inlet Pipe Lower Assembly to the Inlet Pipe Assembly using the supplied clamp. Refer to the table below to select the appropriate extension pipes for your vehicles configuration.

TABLE		
CAB/BED	18" EXTN	30" EXTN
CC/LB	YES	YES
CC/SB	YES	YES
EC/LB	NO	YES
EC/SB	YES	NO

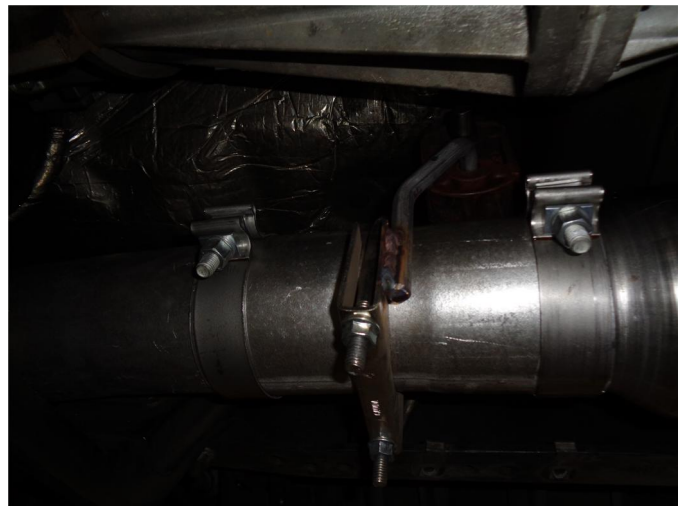

**Step 3.** As you assembly the Extension Pipes loosely locate the Hanger Clamp Assemblies as needed.



**Step 4.** Loosely install the Over Axle Pipe Assembly using the supplied clamps. locate both welded hangers to the rubber insulators.



**Step 5.** Install the Tail Pipe Assembly in the same way. The Outlet may be trimmed as desired.



**Step 6.** Once a final position has been chosen for the new exhaust system, evenly tighten all clamps from front to rear using the torque specifications on page one of the instructions. Inspect all fasteners after 25-50 miles of operation and re-tighten if necessary.