



# BX3835

## 2013-2016 VW Beetle (Includes Turbo) Installation Instructions

**Attachment Tab Height: 13-1/2"**

**Attachment Tab Width: 23"**

**Serial Number**

**Please read BOTH these Installation Instructions and the General Information sheet prior to installing or operating this equipment.**

1. Blue Ox® towing products and accessories are intended to be installed by Blue Ox® Dealers who are familiar with our products and have the equipment and knowledge necessary to do "fit work". If needed, Blue Ox® Dealers can be found at [www.blueox.com](http://www.blueox.com) or by contacting our Technical Service Department at (402) 385-3051.
2. Many Blue Ox® baseplates are designed to use existing holes and hardware to mount the baseplate to the towed vehicle. Even though bolts are there, do not assume they are adequate for baseplate mounting. Always use the hardware supplied in the hardware kit and existing hardware as specified in the installation instructions.

**Bolt Torque Specifications**  
Torque in Foot-Pounds for Inch Bolts

Bolt Size	Grade 5	Grade 8
1/4"	10	14
5/16"	19	29
3/8"	33	47
7/16"	54	78
1/2"	78	119
5/8"	154	230
3/4"	257	380



If the front of your vehicle looks different than this, please contact us at (402)385-3051.

**Bolt Torque Specifications**  
Torque in Foot-Pounds for Metric Bolts

Bolt Size	Grade 8.8	Grade 10.9
6MM	6	8
8MM	16	22
10MM	31	40
12MM	54	70
14MM	89	117
16MM	161	230
18MM	222	318

**Reference your vehicle owner's manual for manufacturer's towing specifications.**

**! WARNING**

Failure to read and follow these instructions could result in separation of the towed vehicle from the tow bar, causing property damage, loss of towed vehicle, personal injury or death.

BX3835  
2013-2016 VW Beetle (Includes Turbo)  
Installation Instructions

**Instruction Notes:** The fascia and horns are removed and reinstalled for the baseplate installation. Some drilling and trimming is required.

Place all components that are removed on a flat, sturdy surface. All items will be reinstalled unless otherwise noted after the baseplate is installed.

The dimensional variations between otherwise identical vehicles can be considerable. While the baseplate was designed for easy installation, it may be necessary to tailor the baseplate slightly to compensate for vehicle manufacturer's tolerances.

The BX8848 4-Diode Wiring Kit is recommended for this vehicle.

## ***NOTICE***

- Handling of some cosmetic parts when installing this product may require the use of protective covers, rags, specialty tools, etc. to prevent damage.
- When using power drills be aware of the dangers of torque and drill bit length.
- When using a reciprocating saw be aware of objects behind the cutting surface.
- Use a good quality paint to spray cut edges of frame to prevent rusting.
- Be sure that **ALL** electrical connections are plugged in and accessories are functioning properly before reinstalling the fascia.
- The baseplate is computer tested to your vehicle's GVWR, exceeding this weight will void the manufacturer's warranty.
- Be sure to use a sufficient amount of Loctite® Red on all bolt threads before tightening. Tighten all bolts according to the torque chart provided.
- Dealer or installer be certain the user receives these instruction sheets.
- If the baseplate is in an accident, it must be replaced. **DO NOT** use it again! An accident can cause unseen damage and using it again could result in more damage or serious injury. **DO NOT** use the baseplate if it is damaged or missing parts.

# BX3835

## 2013-2016 VW Beetle (Includes Turbo)

### Installation Instructions

#### Tools Required

Large Vise Grip  
 Flat Screwdriver  
 Utility Knife  
 Reciprocating Saw  
 Torque Wrench  
 Drill  
 Tape Measure  
 Loctite® RED  
 13/32" Drill Bit  
 1-1/4" Hole Saw  
 13MM Socket  
 9/16" Socket  
 T25 Torx  
 T50 Torx

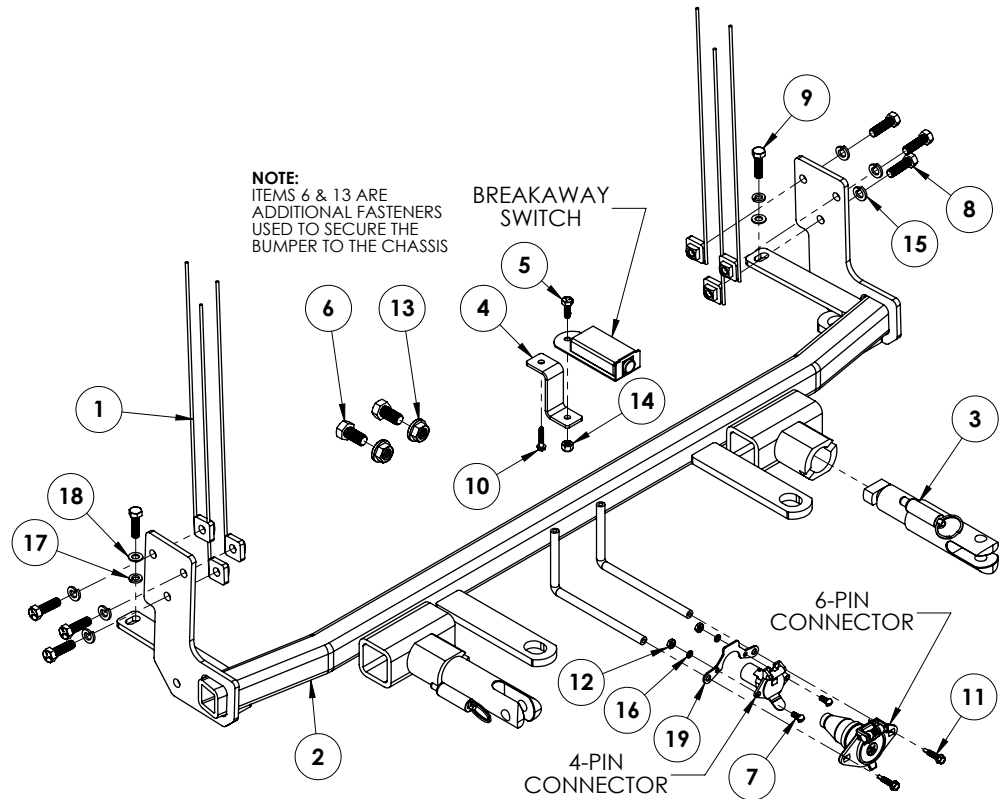

Item No.	Part No.	Description	Qty.
1	61-5208	3/8" Nut Plate w/ 14" Wire	6
2	61-7236	BX3835 Baseplate	1
3	62-3468	Attachment Tab Assembly with Hole	2
4	102-7056	Breakaway Bracket	1
5	201-0050	1/4"-20 x 3/4" Hex Head Bolt, Grade 5, ZP	1
6	201-0060	1/2"-13 x 1" Hex Head Bolt, Grade 5, ZP	2
7	201-0192	#10-32 1/2" Round Slotted Head Screw	2
8	201-0368	3/8"-16 x 1-1/4" Hex Head Bolt, Grade 5, ZP	6
9	201-0446	8MM-1.25 x 30MM Hex Head Bolt, Grade 8.8, ZP	2
10	201-0654	#10-16 x 1" Self Drilling Screw, ZP	1
11	201-0979	#12-14 x 1" Self Drilling Screw, ZP	2
12	202-0047	#10-32 Hex Nut	2
13	202-0072	1/2"-13 Hex Flange Whiz Lock Nut, ZP	2
14	202-0102	1/4"-20 Hex Nylon Nut, ZP	1
15	203-0010	3/8" Lock Washer, ZP	6
16	203-0054	#10 Lock Washer, ZP	2
17	203-0102	8MM Lock Washer, ZP	2
18	203-0107	8MM Flat Washer, ZP	2
19	299-0685	Electrical Bracket	1
20	226-0046(not shown)	Class III Safety Cables	2
21	229-0359(not shown)	3/8" Quicklink, ZP	2
22	290-0437(not shown)	Black Cap Plug Receiver	2

#### **Important:**

Use only genuine factory replacement parts on your baseplate. Do **NOT** substitute homemade or non-typical parts. If a bolt is lost or in need of replacement, for your safety and the preservation of your baseplate, be sure to use a replacement bolt of the same grade (In most cases it will be Grade 5, please reference the parts list above). Replacement parts may be ordered through your nearest Blue Ox® Dealer or Distributor. Failing to follow and/or altering these installation instructions in either installation or required equipment will void the manufacturer's warranty. Towing behind a non-motorized vehicle will void the warranty.

BX3835  
2013-2016 VW Beetle (Includes Turbo)  
Installation Instructions



1. Remove the four (4) push pins from the top edge of the radiator cover. There are two (2) on each side. Then remove cover from vehicle.

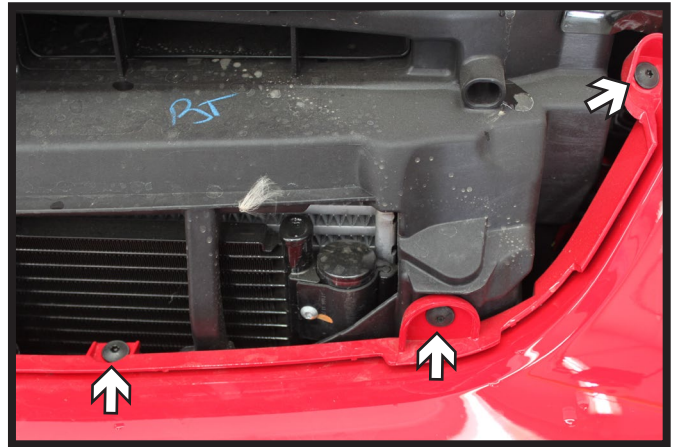

2. Using a T25 Torx, remove the six (6) screws at the top of the fascia. There are three (3) on each side.



3. In the wheel well, use a T25 Torx to remove the three (3) screws. Do this to both sides of the vehicle.

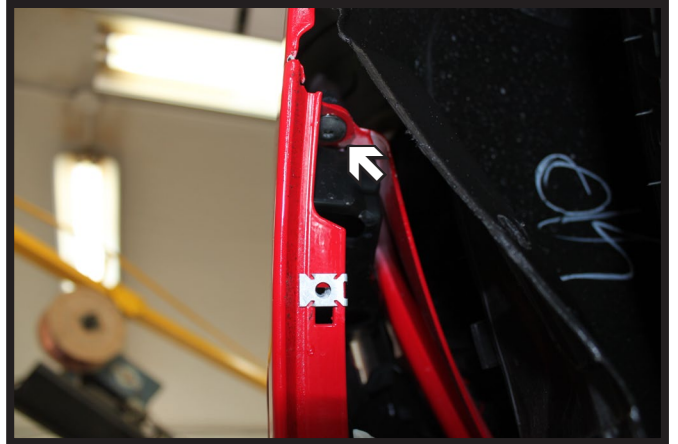

4. Behind the wheel well cover remove the one (1) upper fascia screw with a T25 Torx. Do this to both sides of the vehicle.

BX3835  
2013-2016 VW Beetle (Includes Turbo)  
Installation Instructions



5. Using a T25 Torx, remove the eight (8) screws from the underside of the fascia. There are three (3) on each side and two (2) in the middle.



6. When removing front fascia, pull straight out and unhook both the side marker and running light wiring on both sides of vehicle.

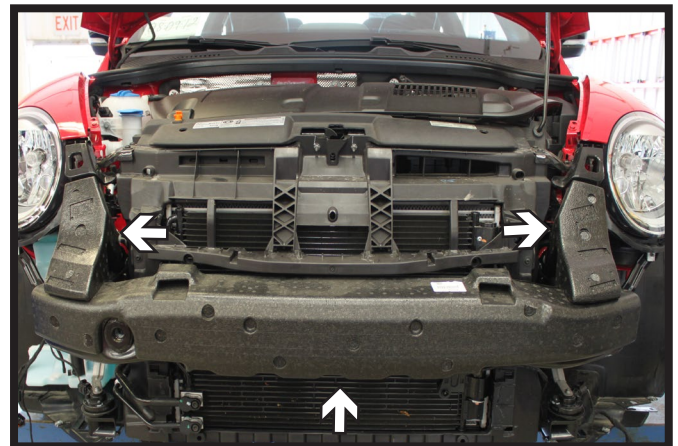

7. Remove the three (3) foam fascia support pieces. DO NOT discard, these will be reinstalled later.



8. Remove the air temperature sensor from the bumper and set aside.

BX3835  
2013-2016 VW Beetle (Includes Turbo)  
Installation Instructions

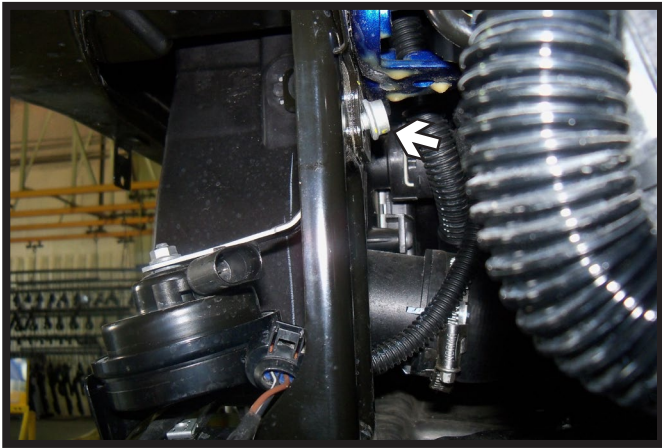

9. Using a T50 Torx, remove the screw from the backside of the horn bracket. Disconnect the wiring and set the horn aside. Do this on both sides of the vehicle.

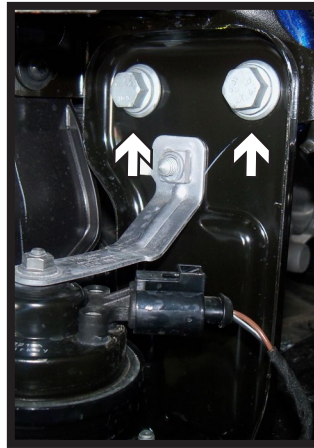

10. Using a 16MM socket, remove the two (2) bolts from the upper section of the brace (left). Using a T50 Torx, remove the two (2) screws from the underside of the brace (right). Do this on both sides of the vehicle.

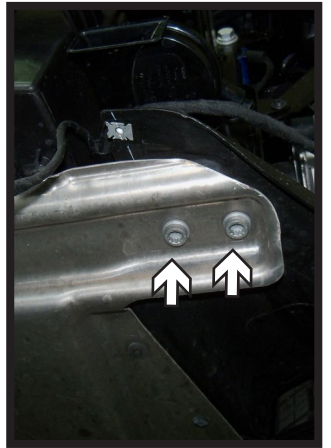

11. Remove the tab the horn was attached to flush with the body, either by bending back and forth with vise-grips as shown or using a reciprocating saw. Repeat on other side of vehicle.  
**WARNING:** If using a reciprocating saw be aware of the fluid reservoir on the passenger side when cutting.

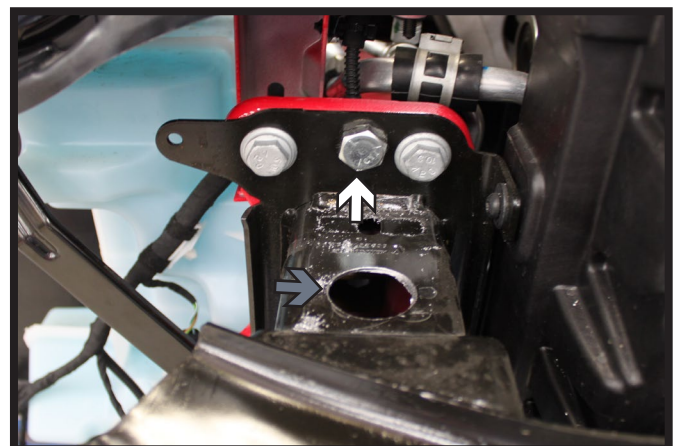

12. Install a 1/2"-13 x 1-1/2" bolt and 1/2"-13 whiz lock nut in the existing frame hole (white).  
Using a 1-1/4" hole saw bit drill a hole in this approximate location for nut plate installation (gray). Do this on both sides of the vehicle.

BX3835  
2013-2016 VW Beetle (Includes Turbo)  
Installation Instructions

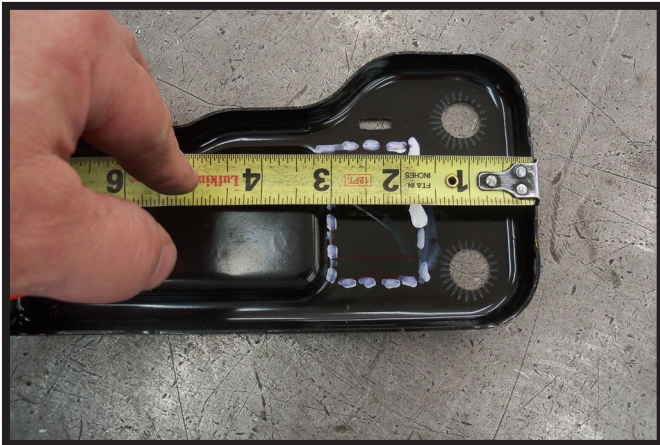

13. Cut a opening in the brace, approximately 1-1/2" down from the top down to the rib and approximately 3/4" from the sides. Do this on both braces.

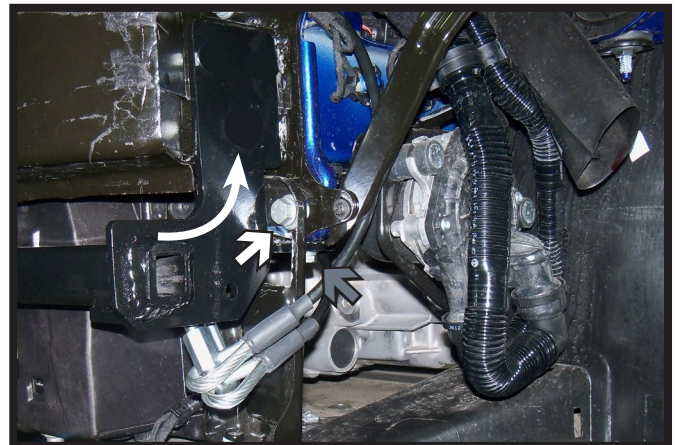

14. Slide the notched braces onto the baseplate and rotate into position on the vehicle. Start the outer existing brace bolt (white) and a 8MM-1.25 x 30MM bolt with a 8MM flat and lock washer into the underside hole of the baseplate (gray). Do this on both sides of the vehicle. Level and clamp the baseplate into position.

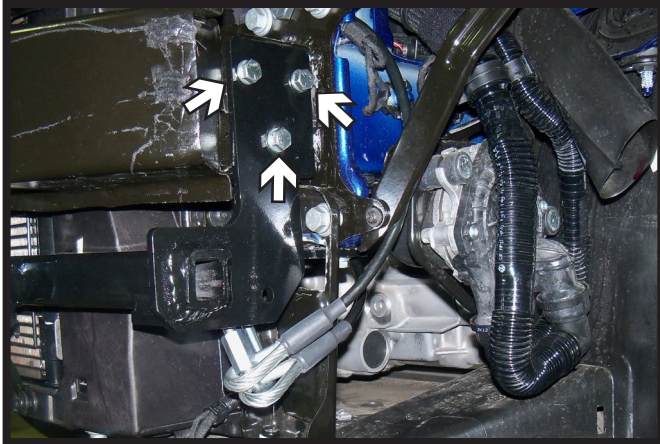

15. Using a 13/32" drill bit, drill the three (3) holes thru the frame. Install 3/8"-16 x 1-1/4" bolts with lock washers into the holes and 3/8"-16 nut plates on the inside of the frame. Do this on both sides of the vehicle. Fully tighten all fasteners.

Reinstall the second upper brace bolt and the two (2) lower screws. Fully tighten both the upper bolts and lower screws along with the 8MM bolt on the underside of the baseplate. Do this on both sides.

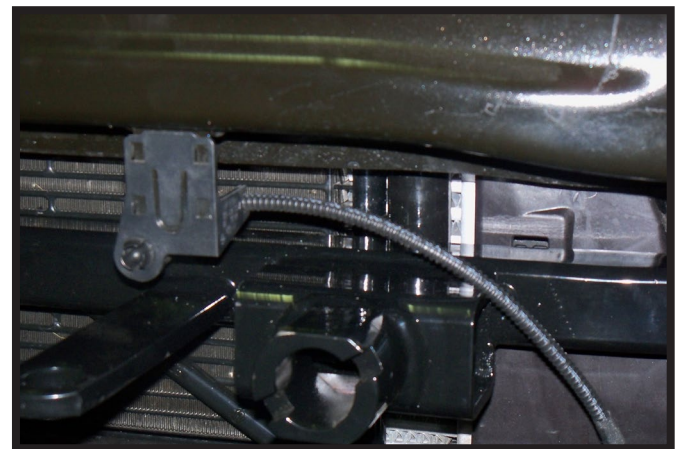

16. Reinstall the air temperature sensor. Note: the bracket may need to be bent out slightly to reinstall the sensor.

BX3835  
2013-2016 VW Beetle (Includes Turbo)  
Installation Instructions

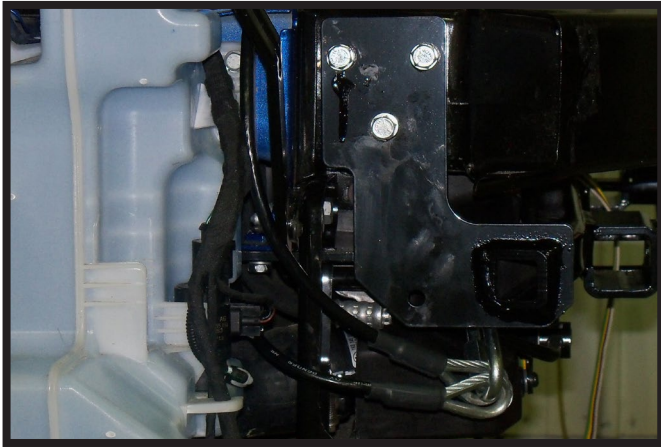

17. Attach the permanent baseplate safety cables to the provided convenience link on the baseplate. The photo shows the recommended installation of the cables to frame of vehicle. Additional options may interfere with suggested mounting; in this case, secure the cables to a solid piece of the frame as described in the instructions included with the permanent baseplate safety cables. Be sure the safety cables do not rub against any hoses or moving parts. Do this on **BOTH** sides of the vehicle.

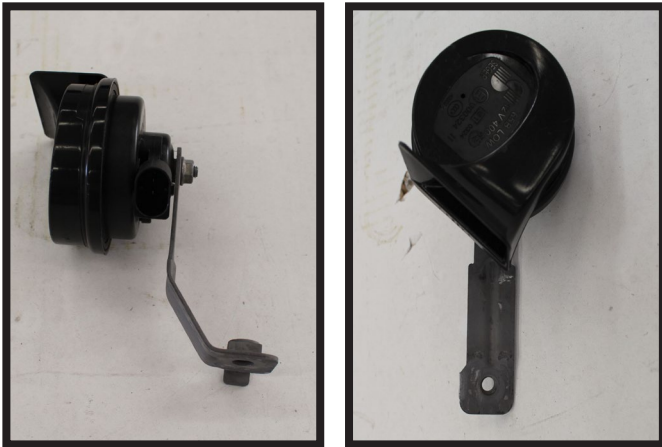

18. Flatten out the horn bracket with a hammer on a solid surface. Then remove the side tab with pliers or vise-grips by twisting back & forth (shown above to left). Bracket should look like right hand picture when done. Repeat on other horn.



19. To relocate the horn, drill a hole thru the brace and install the horn bracket to the brace. Remove the horn from the bracket and bend the bracket around. Reinstall the horn to the bracket and reconnect the wiring. Do this on both sides of the vehicle.



BX3835  
2013-2016 VW Beetle (Includes Turbo)  
Installation Instructions

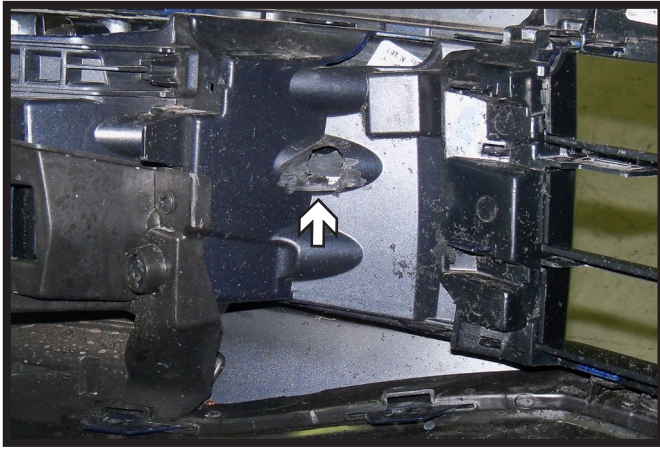

20. On the backside of the fascia, trim off material from the rib for baseplate clearance. Do this on both sides of the fascia.



21. Hold the fascia as close to its original position, mark and trim the fascia around the convenience links and attachment tabs. Reinstall the fascia and fascia cover.

## CUSTOMER SERVICE COMMITMENT

Blue Ox® is committed to providing you with exceptional customer care throughout your lifetime with our products. Our team is here to assist you with any questions you may have regarding the performance of your product. Simply call (402) 385-3051 and you can speak with our technical service team.

Additionally, please visit our website to see which rallies our Destination America team will be attending. For a nominal fee, our service technician will service your towing system to ensure it's in proper working condition. Also, as a commitment to our customers, should you visit our factory, you can stay at our full service Blue Ox® campground at no charge along with enjoying a factory tour.

Again, thank you for being our customer and for the confidence you have shown in the performance of our products. It is because of customers like you we enjoy the success we have today.

© 2015 Blue Ox  
One Mill Road, Industrial Park  
Pender, Nebraska 68047  
Phone: (402) 385-3051  
Fax: (402) 385-3360  
[www.blueox.com](http://www.blueox.com)

# General Information

1. Ensure that your product(s) are registered online at [www.blueox.com](http://www.blueox.com). It is crucial to register your product(s) so that you may be alerted of product offerings, updates, upgrades, maintenance and safety bulletins, and/or recalls.
2. **It is the owner's responsibility to inspect all towing equipment for cracked welds, missing or worn parts and loose bolts before each towing trip.** Be sure to use Loctite® Red on all bolts and tighten to the recommended specifications.
3. **It is the owner's responsibility to hook up all towing equipment per manufacturer's instructions/recommendations.**
4. Remove the attachment tabs when not in use (if applicable).

## Notice To Baseplate Installer

### 1. It is YOUR responsibility to watch for:

- Oil cooler and air conditioner lines
- Electrical wires and hoses
- Missing parts or attaching points on the frame

\*\* If the baseplate is improperly installed and is against a wire or hose, it could cause fluid leaks or electrical shorts some time after the actual baseplate installation.

## Permanent Baseplate Safety Cable Installation

Permanent baseplate safety cables are strongly recommended when towing a vehicle with a tow bar. The principle function of the permanent baseplate safety cables is to prevent the towed vehicle from breaking loose in the event the connection between the frame of the towed vehicle and the baseplate fails or becomes disconnected. The cables must be connected from the baseplate to the frame rail or cross member of the vehicle's frame. The illustrations below show the possible arrangements recommended by Blue Ox®. Each permanent baseplate safety cable must have an adequate weight rating for the towing system. The weight rating of the two (2) cables together will not qualify.

***Do not mount the permanent baseplate safety cables against wires, hoses or brake lines.***

These permanent baseplate safety cables should remain installed as long as the baseplate is installed on the vehicle. Permanent baseplate safety cables are to be used in conjunction with, and NOT a replacement for legally required safety cables attaching the towed vehicle to the towing vehicle.

### OPTION #1

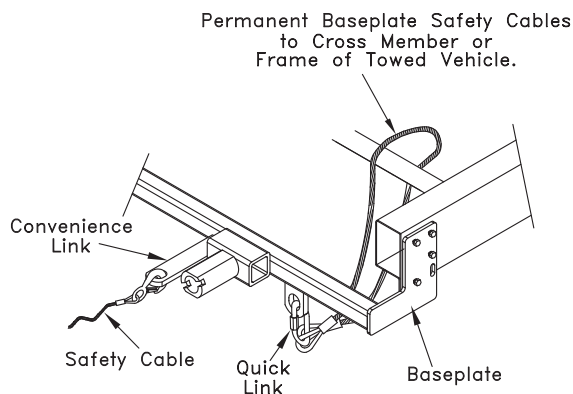

### OPTION #2

