



BX2645

2013-15 Lincoln MKS (Includes Adaptive Cruise & EcoBoost)
2013-19 Lincoln MKT (Includes Adaptive Cruise & EcoBoost)
2013-19 Ford Flex (Includes Adaptive Cruise & EcoBoost)
Installation Instructions

Please read **BOTH** these Installation Instructions and the General Instructions prior to installing or operating this equipment.



If the front of your vehicle looks different than this, please contact us at (402)385-3051.

Serial Number

Attachment Tab Height: 15"

Attachment Tab Width: 20"

1. Blue Ox® towing products and accessories are intended to be installed by Blue Ox® Dealers who are familiar with our products and have the equipment and knowledge necessary to do "fit work". If needed, Blue Ox® Dealers can be found at www.blueox.com or by contacting our Technical Service Department at (402) 385-3051.
2. Many Blue Ox® baseplates are designed to use existing holes and hardware to mount the baseplate to the towed vehicle. Even though bolts are there, do not assume they are adequate for baseplate mounting. Always use the hardware supplied in the hardware kit and existing hardware as specified in the installation instructions.



WARNING

Failure to read and follow these instructions could result in separation of the towed vehicle from the tow bar, causing property damage, loss of towed vehicle, personal injury or death.

Reference your vehicle owner's manual for manufacturer's towing specifications.

BX2645

2013-2015 Lincoln MKS; 2013-2019 Lincoln MKT; 2013-2019 Ford Flex (Includes Adaptive Cruise Control & EcoBoost) Installation Instructions

Instruction Notes: The fascia, horn and windshield washer fluid reservoir are removed and reinstalled for the baseplate installation. Some drilling and trimming is required.

Place all components that are removed on a flat, sturdy surface. All items will be reinstalled unless otherwise noted after the baseplate is installed.

The dimensional variations between otherwise identical vehicles can be considerable. While the baseplate was designed for easy installation, it may be necessary to tailor the baseplate slightly to compensate for vehicle manufacturer's tolerances.

The BX8848 Tail Light Wiring Kit is recommended for the 2013-2017 Ford Flex. For the 2013-15 Lincoln MKS and 2013-16 Lincoln MKT please contact Blue Ox Technical Support Team at (800) 228-9289 to determine the proper wiring kit for these vehicles.

NOTICE

- Handling of some cosmetic parts when installing this product may require the use of protective covers, rags, specialty tools, etc. to prevent damage.
- When using power drills be aware of the dangers of torque and drill bit length.
- When using a reciprocating saw be aware of objects behind the cutting surface.
- Use a good quality paint to spray cut edges of frame to prevent rusting.
- Be sure that **ALL** electrical connections are plugged in and accessories are functioning properly before reinstalling the fascia.
- The baseplate is computer tested to your vehicle's GVWR, exceeding this weight will void the manufacturer's warranty.
- Be sure to use a sufficient amount of Loctite® Red on all bolt threads before tightening. Tighten all bolts according to the torque chart provided.
- Dealer or installer be certain the user receives these instruction sheets.
- If the baseplate is in an accident, it must be replaced. **DO NOT** use it again! An accident can cause unseen damage and using it again could result in more damage or serious injury. **DO NOT** use the baseplate if it is damaged or missing parts.

Bolt Torque Specifications		
Torque in Foot-Pounds for Inch Bolts		
Bolt Size	Grade 5	Grade 8
1/4"	10	14
5/16"	19	29
3/8"	33	47
7/16"	54	78
1/2"	78	119
5/8"	154	230
3/4"	257	380

Bolt Torque Specifications		
Torque in Foot-Pounds for Metric Bolts		
Bolt Size	Grade 8.8	Grade 10.9
6MM	6	8
8MM	16	22
10MM	31	40
12MM	54	70
14MM	89	117
16MM	161	230
18MM	222	318

BX2645

2013-2015 Lincoln MKS; 2013-2019 Lincoln MKT; 2013-2019 Ford Flex
(Includes Adaptive Cruise Control & EcoBoost)

Installation Instructions

Tools Required

- Large Vise Grip
- Flat Screwdriver
- Utility Knife
- Phillips Screwdriver
- Hammer
- Torque Wrench
- Drill
- Reciprocating Saw
- Tape Measure
- Loctite® RED
- 1/4" Drill Bit
- 13/32" Drill Bit
- 17/32" Drill Bit
- 5.5MM Socket
- 8MM Socket
- 10MM Socket
- 9/16" Socket

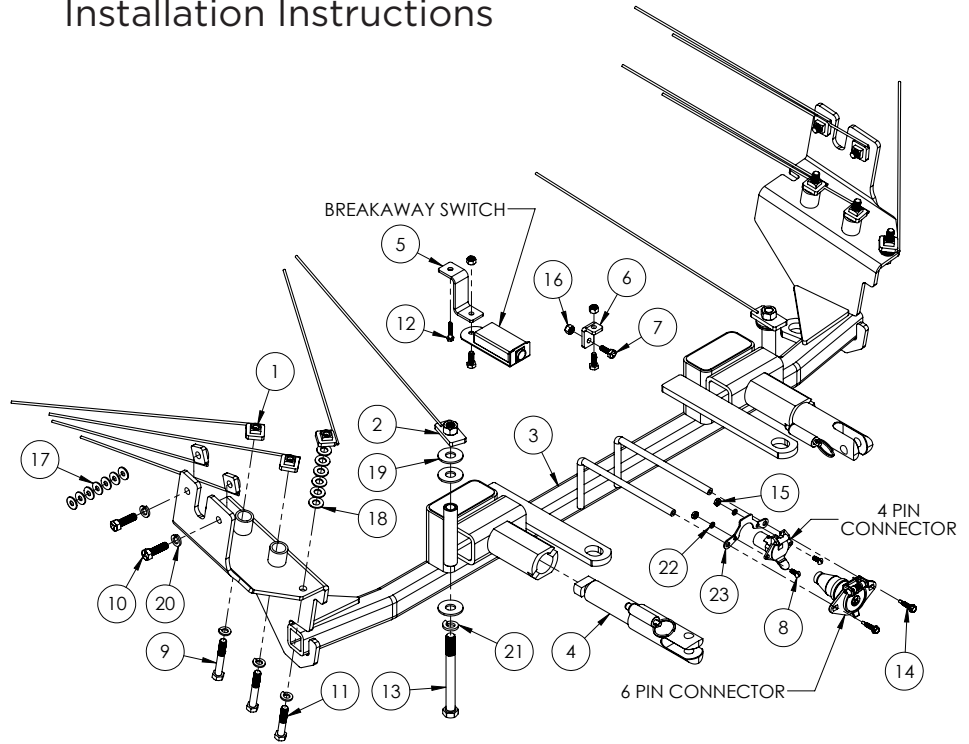

Item No.	Part No.	Description	Qty.
1.....	61-5208	3/8"-16 Nut Plate with 14" Wire	10
2.....	61-5496	1/2" Nut Plate with Wire	2
3.....	61-7223	BX2645 Baseplate	1
4.....	62-3469	Attachment Tab Assembly with Hole.....	2
5.....	102-7056	Breakaway Bracket.....	1
6.....	102-7401	Support Bracket.....	1
7.....	201-0050	1/4"-20 x 3/4" Hex Head Bolt, Grade 5, ZP.....	3
8.....	201-0192	#10-32 1/2" Round Slotted Head Screw	2
9.....	201-0336	3/8"-16 x 2-1/2" Hex Head Bolt, Grade 5, ZP	4
10.....	201-0368	3/8"-16 x 1-1/4" Hex Head Bolt, Grade 5, ZP	4
11.....	201-0444	3/8"-16 x 2" Hex Head Bolt, Grade 5, ZP.....	2
12.....	201-0654	#10-16 x 1" Self Drilling Screw, ZP	1
13.....	201-0786	1/2"-13 x 5" Hex Head Bolt, Grade 5, ZP.....	2
14.....	201-0979	#12-14 x 1" Self Drilling Screw, ZP	2
15.....	202-0047	#10-32 Hex Nut	2
16.....	202-0102	1/4"-20 Hex Nylon Nut, ZP.....	3
17.....	203-0001	1/4" Flat Washer, ZP.....	7
18.....	203-0003	3/8" Flat Washer, ZP.....	12
19.....	203-0005	1/2" Flat Washer, ZP.....	6
20.....	203-0010	3/8" Lock Washer, ZP	10
21.....	203-0012	1/2" Lock Washer, ZP	2
22.....	203-0054	#10 Lock Washer, ZP	2
23.....	299-0685	4-Way Bracket	1
24.....	226-0049(not shown).....	Class Iv Safety Cables	2
25.....	229-0512(not shown).....	1/2" Quicklink, ZP	2
26.....	290-0437(not shown).....	Black Cap Plug Receiver.....	2

Important:

Use only genuine factory replacement parts on your baseplate. Do **NOT** substitute homemade or non-typical parts. If a bolt is lost or in need of replacement, for your safety and the preservation of your baseplate, be sure to use a replacement bolt of the same grade (In most cases it will be Grade 5, please reference the parts list above). Replacement parts may be ordered through your nearest Blue Ox® Dealer or Distributor. Failing to follow and/or altering these installation instructions in either installation or required equipment will void the manufacturer's warranty. Towing behind a non-motorized vehicle will void the warranty.

2013-2015 Lincoln MKS; 2013-2019 Lincoln MKT; 2013-2019 Ford Flex
 (Includes Adaptive Cruise Control & EcoBoost)
 Installation Instructions

FASCIA & GRILLE REMOVAL FOR LINCOLN MKS ONLY

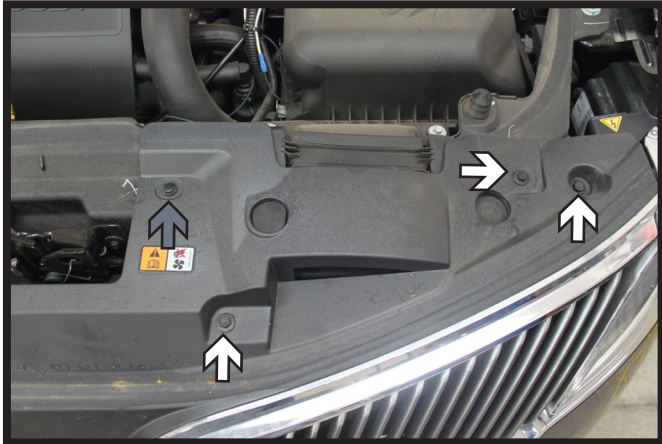

1. Using a 10MM socket, remove the six (6) screws from the top edge of the fascia. There are three (3) on each side (white). Remove the push pins from either side of the latch mechanism (gray).

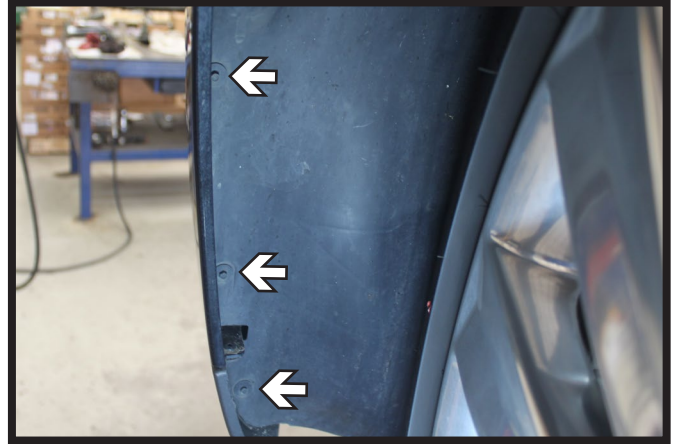

2. Using a 5.5MM socket, remove the three (3) screws from the wheel well. Do this on both sides of the vehicle.

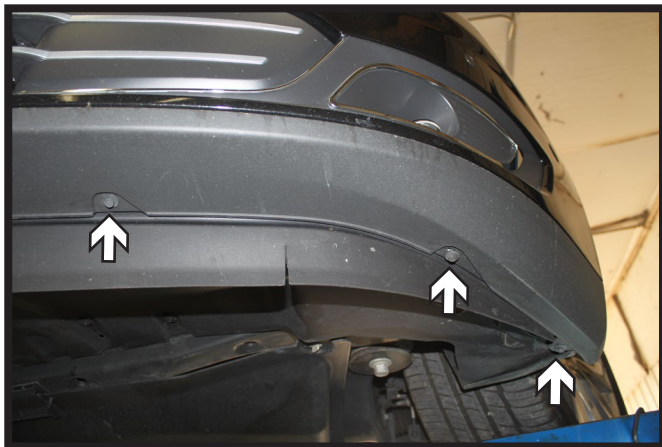

3. Using a 8MM socket, remove the seven (7) screws from the underside of the fascia. There are three (3) on each side and one (1) in the middle.

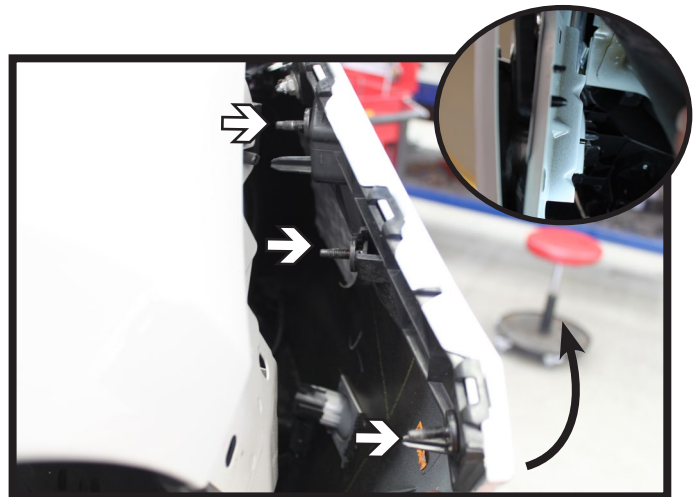

4. Pull back the wheel well liner, then using a 10MM socket, remove the three (3) nuts from inside of the fender. Then pull the corner of the fascia outward and forward. Do this on both sides of the vehicle. Disconnect all electrical connections and set the fascia aside.

After the fascia is removed continue to page 7

BX2645

2013-2015 Lincoln MKS; 2013-2019 Lincoln MKT; 2013-2019 Ford Flex
(Includes Adaptive Cruise Control & EcoBoost)

Installation Instructions

FASCIA & GRILLE REMOVAL FOR LINCOLN MKT ONLY



1. Using a 10MM socket, remove one (1) bolt from the top of the fascia (white). Also remove the two (2) push pins using a Phillips screwdriver (gray). Do this on both sides of the vehicle.



2. Using a 5.5MM socket, remove the three (3) screws from the outer edge of the wheel well. Do this on both sides of the vehicle.



3. Remove the three (3) push pins from the underside of the fascia.

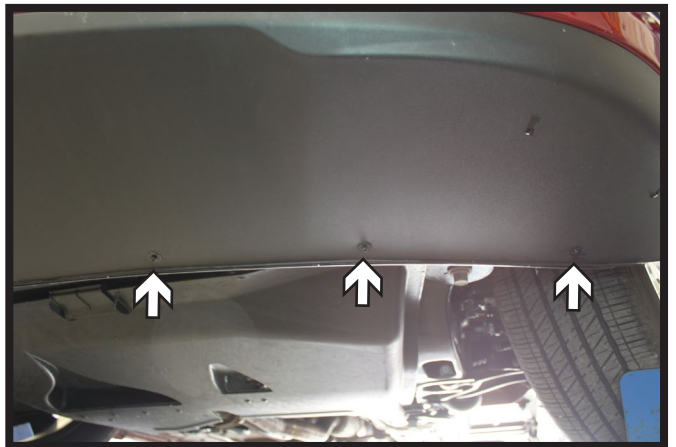

4. Using a 5.5MM socket, remove the seven (7) screws from the underside of the fascia. Pull the fascia forwards disconnecting all electrical connections and set the fascia aside.

After the fascia is removed continue to page 7

2013-2015 Lincoln MKS; 2013-2019 Lincoln MKT; 2013-2019 Ford Flex
 (Includes Adaptive Cruise Control & EcoBoost)
 Installation Instructions

FASCIA & GRILLE REMOVAL FOR FORD FLEX ONLY

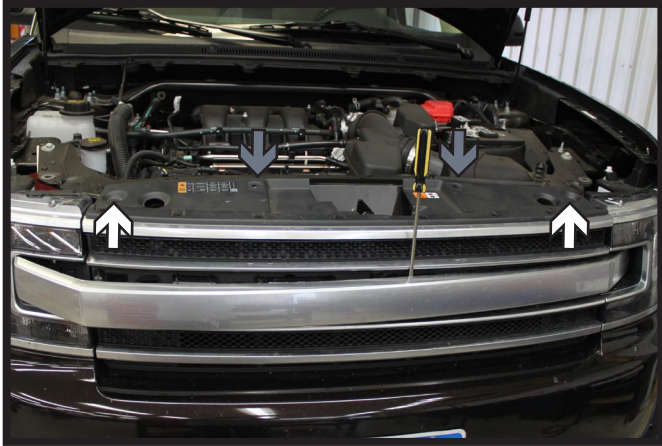

1. Using a 10MM socket, remove the two (2) screws (white). Then remove the two (2) Phillips head push pins (gray) from the top of the grille. Then using a straight screwdriver pop out the chrome trim insert straight out from the grille.

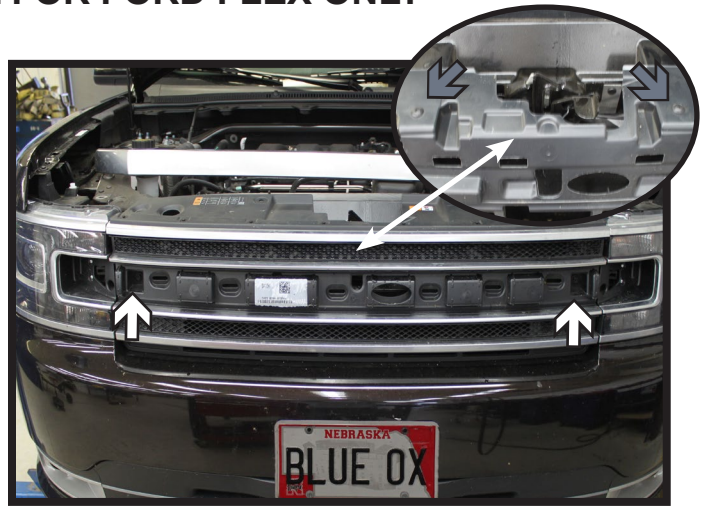

2. Using a 10MM socket, remove the two (2) screws from the face of the grille. Remove the grille from the vehicle and set aside.

Underneath the grille, remove the two (2) push pins from either side of hood latch (gray).



3. Using a 5.5MM socket, remove the three (3) screws from the outer edge of the wheel well. Then on the inner lower edge of the wheel well, remove the one (1) push pin (inset). Do this on both sides of the vehicle.

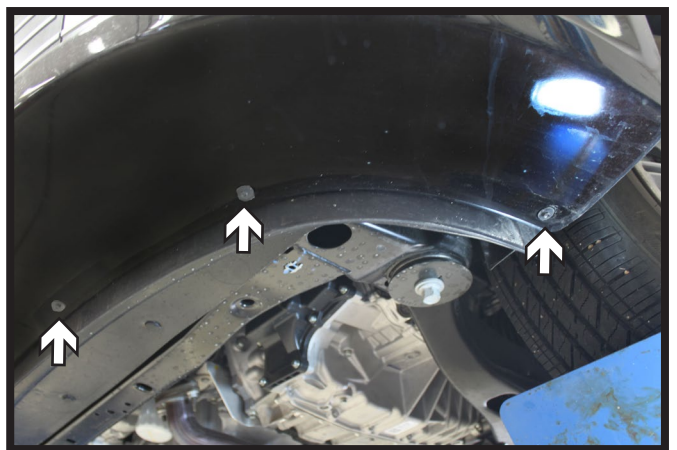

4. Using a 5.5MM socket, remove the screws from the underside of the fascia. Pull the fascia forwards disconnecting all electrical connections and set the fascia aside.

2013 Models: Will have eight (8) screws
 2014 Models: Will have seven (7) screws

BX2645

2013-2015 Lincoln MKS; 2013-2019 Lincoln MKT; 2013-2019 Ford Flex
(Includes Adaptive Cruise Control & EcoBoost)

Installation Instructions

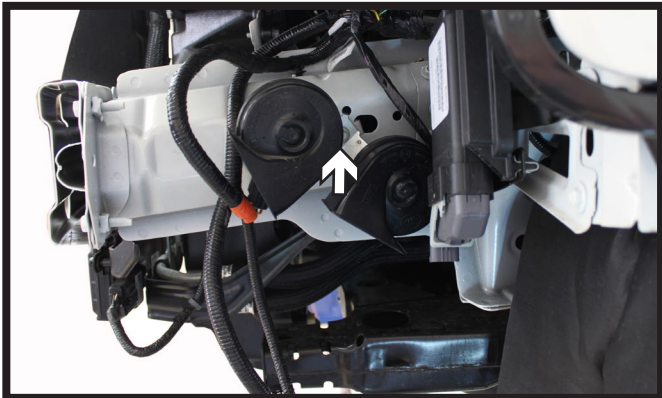

5. On the driver side, using a 8MM socket, remove one (1) bolt from the horn bracket and set aside.

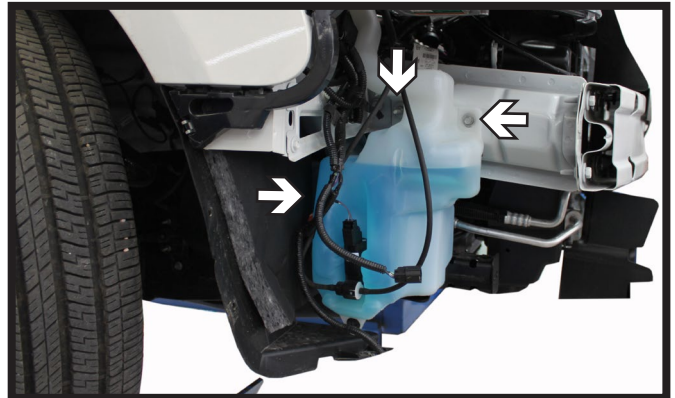

6. On the passenger side, using a 10MM socket, remove the three (3) screws from the washer reservoir. There are two (2) on the front and one (1) on the backside. Disconnect/plug all lines and set reservoir aside.

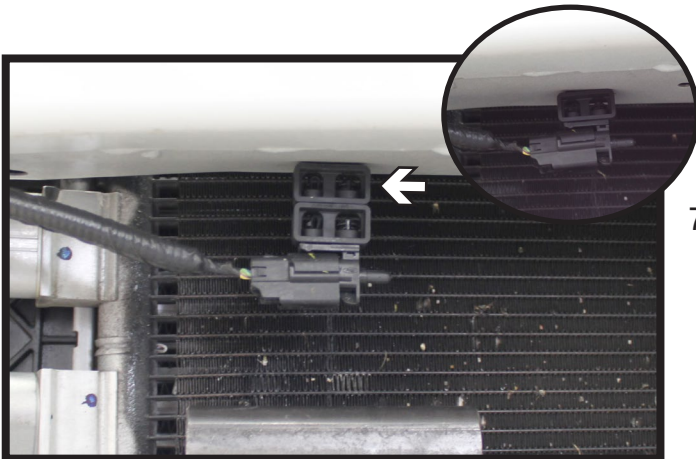

7. On the passenger's side, unclip the air temperature sensor from the bumper.

Remove the top block and reattach the sensor to the bumper (inset).



8. **Non-Active Shutters:** Trim the plastic shrouding off just below the bumper as shown for baseplate clearance. Do this on both sides of the vehicle.

Active Shutters: Trim the plastic shrouding off just below the bumper along the face of the shutter to the base then back out as shown for baseplate clearance. Do this on both sides of the vehicle. Then in the center of the shutter trim off the tab back flush to the shutter face.

BX2645

2013-2015 Lincoln MKS; 2013-2019 Lincoln MKT; 2013-2019 Ford Flex (Includes Adaptive Cruise Control & EcoBoost) Installation Instructions

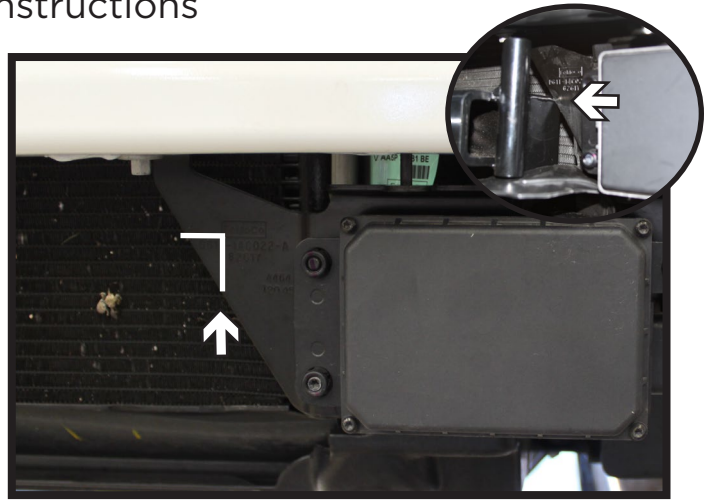
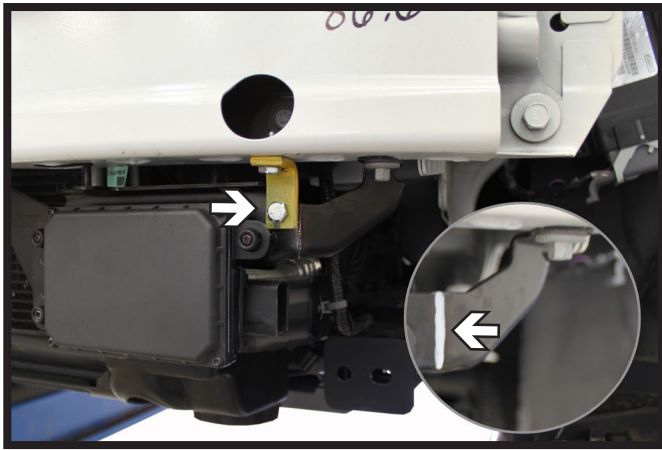

9. **Adaptive Cruise Control Models:** On the driver side, install the support bracket onto the bumper and ACC sensor bracket as shown. Mark and drill the holes with a 1/4" drill bit. Attach the bracket with 1/4"-20 x 3/4" bolts and 1/4"-20 lock nuts. Once the bracket is installed, use a reciprocating saw to remove the outer edge of the ACC bracket (inset).

On the inner side of the ACC bracket, a notch will need to be made for baseplate clearance. Position the baseplate onto the frame as close to its installed position and mark the bracket for trimming. If trimming the bracket on the vehicle be aware of the radiator behind.

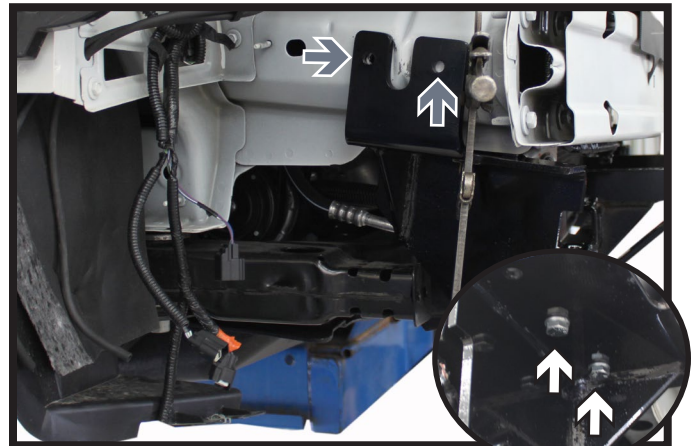
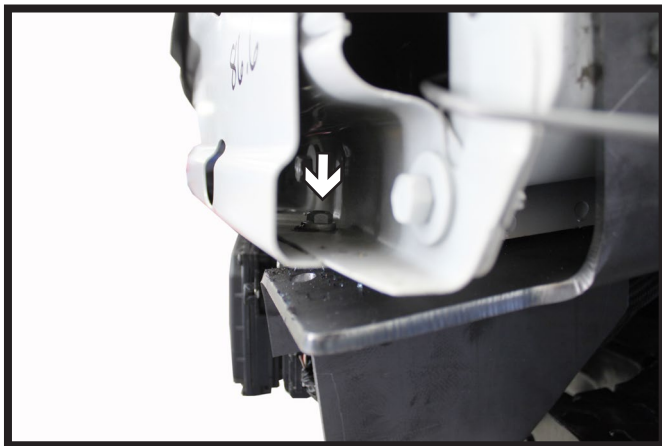

10. On the driver side bumper, using a chisel or flat screwdriver, remove the nut welded on the inside of the bumper for bolt clearance on step #13.
11. Slide the baseplate onto the frame, level and clamp in position. Using a 13/32" drill bit, drill the bottom four (4) holes on the baseplate thru the frame (white). There are two (2) on each side. Install 3/8" x 2-1/2" bolts with lock washers into the holes and 3/8" nut plates in the frame. Fully tighten all four (4) fasteners. Continue drilling the sideplate holes on both sides (gray). Install 3/8" x 1-1/4" bolts with lock washers into these holes with 3/8" nut plates in the frame and fully tighten the fasteners.

** Use Loctite® Red on all bolt threads and tighten all bolts to the appropriate torque.

BX2645

2013-2015 Lincoln MKS; 2013-2019 Lincoln MKT; 2013-2019 Ford Flex (Includes Adaptive Cruise Control & EcoBoost) Installation Instructions

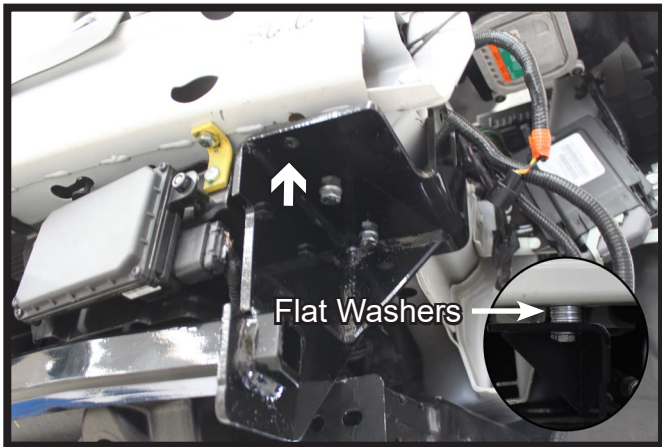

12. Using a 13/32" drill bit, drill the bottom front hole on both sides of the vehicle. Install 3/8" x 2" bolts with lock washers into the holes using flat washers in between the baseplate and frame as spacers (approximately six per side) and 3/8" nut plates in the bumper.

**** Use Loctite® Red on all bolt threads and tighten all bolts to the appropriate torque. ****

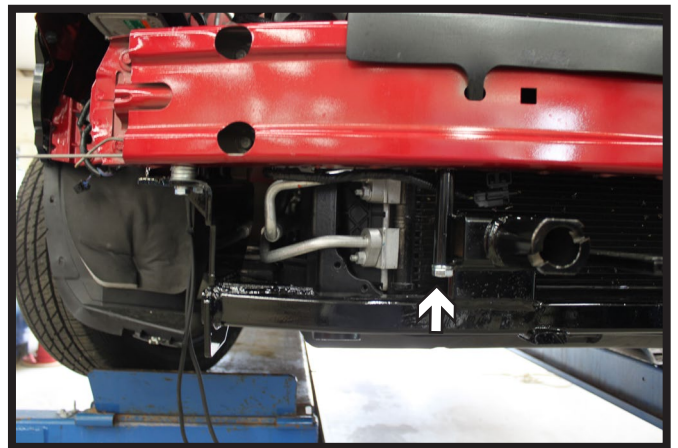

13. Using a 17/32" drill bit, drill a hole thru the bumper using the tube as a guide. Install a 1/2" x 5" bolt with flat and lock washer into the hole and a 1/2" nut plate in the bumper. Depending on the fit, 1/2" flat washers may need to be used in between the bumper and tube. Do this on both sides of the vehicle.

**** Use Loctite® Red on all bolt threads and tighten all bolts to the appropriate torque. ****



14. Prior to reinstalling the washer reservoir, trim the front mounting tab off as shown.

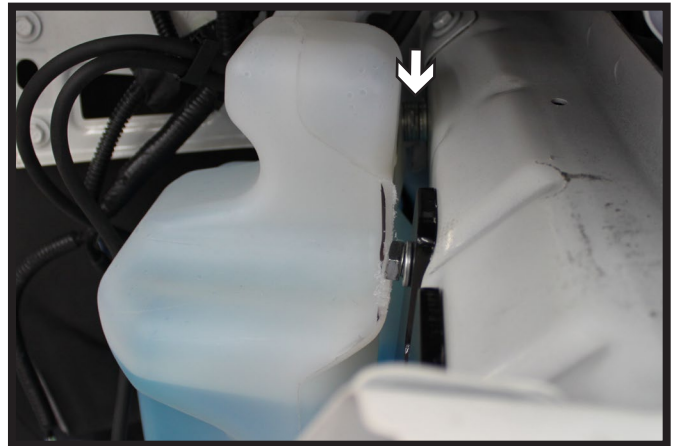

15. Reinstall the washer reservoir to the vehicle, using seven (7) 1/4" flat washers as a spacer on the top back hole to keep the reservoir from rubbing on the baseplate.

BX2645

2013-2015 Lincoln MKS; 2013-2019 Lincoln MKT; 2013-2019 Ford Flex (Includes Adaptive Cruise Control & EcoBoost) Installation Instructions

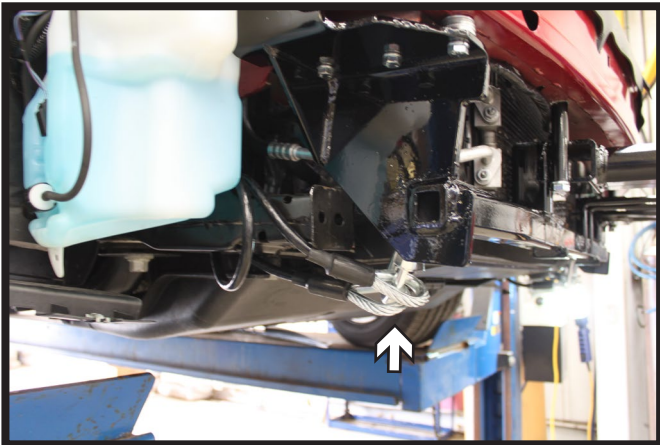

16. Attach the permanent baseplate safety cables to the provided convenience link on the baseplate. The photo above shows the recommended installation of the cables to frame of vehicle. Additional options may interfere with suggested mounting; in this case, secure the cables to a solid piece of the frame as described in the instructions included with the permanent baseplate safety cables. Be sure the safety cables do not rub against any hoses or moving parts. Do this on **BOTH** sides of the vehicle.

17. Reinstall the horn bracket, which may need slight bending to clear baseplate.

Hold the fascia as close to its original position, mark and trim the fascia around the convenience links and attachment tabs. **Important:** Ensure that nothing is installed in front of the ACC sensor (Refer to Step #9 picture). Obstructions will cause false readings from the sensor. Reinstall the fascia.

CUSTOMER SERVICE COMMITMENT

Blue Ox® is committed to providing you with exceptional customer care throughout your lifetime with our products. Our team is here to assist you with any questions you may have regarding the performance of your product. Simply call (402) 385-3051 and you can speak with our technical service team.

Additionally, please visit our website to see which rallies our Destination America team will be attending. For a nominal fee, our service technician will service your towing system to ensure it's in proper working condition. Also, as a commitment to our customers, should you visit our factory, you can stay at our full service Blue Ox® campground at no charge along with enjoying a factory tour.

Again, thank you for being our customer and for the confidence you have shown in the performance of our products. It is because of customers like you we enjoy the success we have today.

© 2016 Blue Ox
One Mill Road, Industrial Park
Pender, Nebraska 68047
Phone: (402) 385-3051
Fax: (402) 385-3360
www.blueox.com

General Information

1. Ensure that your product(s) are registered online at www.blueox.com. It is crucial to register your product(s) so that you may be alerted of product offerings, updates, upgrades, maintenance and safety bulletins, and/or recalls.
2. **It is the owner's responsibility to inspect all towing equipment for cracked welds, missing or worn parts and loose bolts before each towing trip.** Be sure to use Loctite® Red on all bolts and tighten to the recommended specifications.
3. **It is the owner's responsibility to hook up all towing equipment per manufacturer's instructions/recommendations.**
4. Remove the attachment tabs when not in use (if applicable).

Notice To Baseplate Installer

1. It is YOUR responsibility to watch for:

- Oil cooler and air conditioner lines
- Electrical wires and hoses
- Missing parts or attaching points on the frame

** If the baseplate is improperly installed and is against a wire or hose, it could cause fluid leaks or electrical shorts some time after the actual baseplate installation.

Permanent Baseplate Safety Cable Installation

Permanent baseplate safety cables are strongly recommended when towing a vehicle with a tow bar. The principle function of the permanent baseplate safety cables is to prevent the towed vehicle from breaking loose in the event the connection between the frame of the towed vehicle and the baseplate fails or becomes disconnected. The cables must be connected from the baseplate to the frame rail or cross member of the vehicle's frame. The illustrations below show the possible arrangements recommended by Blue Ox®. Each permanent baseplate safety cable must have an adequate weight rating for the towing system. The weight rating of the two (2) cables together will not qualify.

Do not mount the permanent baseplate safety cables against wires, hoses or brake lines.

These permanent baseplate safety cables should remain installed as long as the baseplate is installed on the vehicle. Permanent baseplate safety cables are to be used in conjunction with, and NOT a replacement for legally required safety cables attaching the towed vehicle to the towing vehicle.

OPTION #1

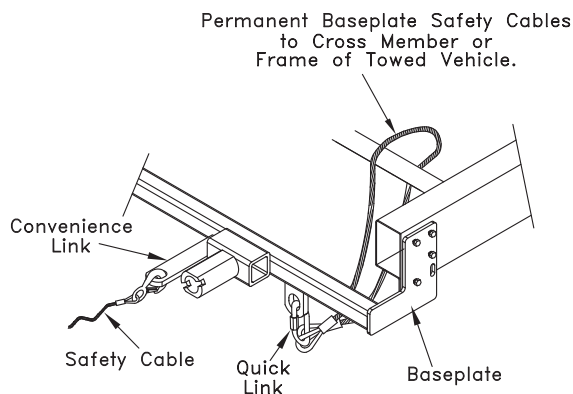

OPTION #2

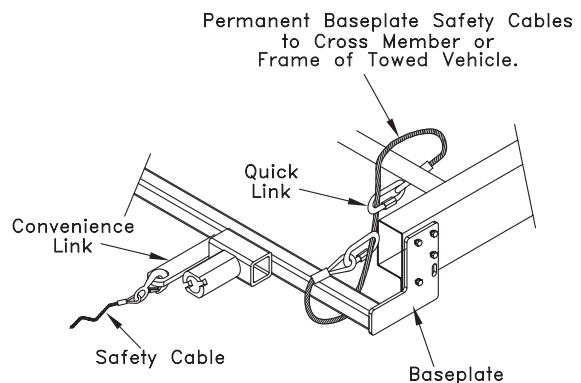

BLUE OX ORIGINAL PURCHASERS THREE YEAR LIMITED WARRANTY

Automatic Equipment Manufacturing Company ("Automatic") warrants to the original (first) retail purchaser that this product, manufactured by Automatic, shall be free from defect in material and workmanship under normal use and service for a period of three years from the date of delivery.

During said three-year period, Automatic will repair or replace any parts that have been returned by the original purchaser, to the factory, transportation prepaid, and in Automatic's sole and absolute opinion found to be defective.

Limitations on Warranty Coverage:

Coverage under this warranty will be valid only if the customer warranty card is returned by the original purchaser within 30 days of purchase.

Coverage under this warranty will be effective only when a copy of the original invoice, showing date and place of purchase, accompanies any claim for warranty. This warranty is NON TRANSFERABLE.

This limited warranty will not cover, in any way or form, any alleged damages caused by incorrect or improper installation, improper use, modification or neglect of product, failure to properly service and maintain, misuse, act of God, accident or failure of the user to follow guidelines contained in the instructional material provided by Automatic.

This warranty does not cover normal wear and tear, paint or rust.

Warrantor assumes no responsibility to the owner for loss of use of product, loss of time, inconvenience or any other damage consequential or otherwise. Including, but not limited to mileage, expense of transporting of product, return shipping expense, mechanics travel time, telephone, road service, towing, and rental during repairs, travel, lodging, loss or damage to personal property or loss of earnings.

REPAIR OR REPLACEMENT AS SET FORTH IN THIS LIMITED WARRANTY IS THE SOLE EXCLUSIVE REMEDY OF THE PURCHASER. AUTOMATIC SHALL NOT BE LIABLE FOR ANY INCIDENTAL OR CONSEQUENTIAL DAMAGES FOR BREACH OF ANY EXPRESS OR IMPLIED WARRANTY ON THIS PRODUCT. EXCEPT TO THE EXTENT PROHIBITED BY APPLICABLE LAW, ANY IMPLIED WARRANTY OF MERCHANTABILITY OR FITNESS FOR A PARTICULAR PURPOSE ON THIS PRODUCT IS LIMITED IN LENGTH TO THE DURATION OF THIS WARRANTY.

Please visit <http://blueox.com/warranty/> to register your warranty



BLUE OX