



# BLUE OX®

## Baseplate Installation Instructions

# BX3826

## 2007-09 VW Rabbit 2.5 w/out foglights

## Installation Instructions

**Serial Number**

**Please read BOTH these Installation Instructions and the General Instructions before attempting to install or operate this equipment.**

- Blue Ox® towing products and accessories are intended to be installed by Blue Ox® Dealers who are familiar with our products and have the equipment necessary and knowledge to do "fit work". When necessary Blue Ox® Dealers can be found at [www.blueox.us](http://www.blueox.us) or by contacting our Customer Care Department at (402) 385-3051.
- Many Blue Ox® Baseplates are designed to use existing holes and hardware to mount the baseplate to the towed vehicle. Even though bolts are there, do not assume they are adequate for baseplate mounting. Always use hardware supplied in the hardware kit and existing hardware specified in the Baseplate Installation Instructions.

Attachment Tab Height: 12"

Attachment Tab Width: 22"

**Bolt Torque Specifications**  
Torque in Foot-Pounds per Metric Bolts

Bolt Size	Grade 8.8	Grade 10.9
6MM	6	8
8MM	16	22
10MM	31	40
12MM	54	70
14MM	89	117

Confirm the and pre-towing procedures for your vehicle with the owner's manual or contact the vehicle's manufacturer for specific towing procedures. You can also contact REMCO for additional information at 1(800)228-2481.

**Bolt Torque Specifications**  
Torque in Foot-Pounds per Inch Bolts

Bolt Size	Grade 5	Grade 8
1/4"	10	14
5/16"	19	29
3/8"	33	47
7/16"	54	78
1/2"	78	119
5/8"	154	230



**! WARNING**

Failure to read and follow these instructions could result in separation of the towed vehicle from the tow bar, causing property damage, loss of towed vehicle, personal injury or death.

# BX3826

2007-09 VW Rabbit 2.5 w/out foglights

## Installation Instructions

### Parts List

Ref. No.	Qty.	Part #	Description
1	1	61-6410	WLDM'T, BASEPLATE, BX3826
2	8	61-5208	WLDT, NUT PLT, 1/4 X 1 X 1, 3/8 BLT
3	8	201-0368	3/8-16 X 1 1/4" HEX HEAD BOLT GRD 5 ZP
4	8	203-0010	3/8 LOCK WASHER, ZP
5	6	203-0003	3/8 FLAT WASHER, ZP
6	1	201-0702	6MM-1.00 X 45MM HEX BOLT, GRD 8.8,
7	1	203-0161	6MM, LOCK WASHER, ZP
8	1	203-0002	5/16 FLAT WASHER, ZP
9	2	201-0979	#12-14 X 1" SELF DRILLING SCREW, ZP
10	2	201-0192	10-32 X 1/2 SLOT, RD. HD. SCREW
11	2	203-0054	#10 LOCK WASHER
12	2	202-0047	#10-32 HEX NUT
13	2	101-5822	ADAPTER, 4 WAY CONNECTOR
14	2	62-3468	ATT TAB ASSY, REM, SF/SB, 1 HOLE
	2	226-0046	BASEPLATE SAFETY CABLE, 36" CL III (Not Shown)
	2	229-0359	QUICKLINK, 3/8, ZP (Not Shown)
	2	290-0437	RECEIVER, CAP PLUG (BLK) (Not Shown)

### Tools Required

T-25 Torx Socket	T-27 Torx Socket
T-30 Torx Socket	9/16" Socket
10MM Socket	13MM Socket
16MM Socket	1 1/4" Hole Saw
13/32" Drill Bit	Reciprocating Saw
Large Clamp	Utility Knife

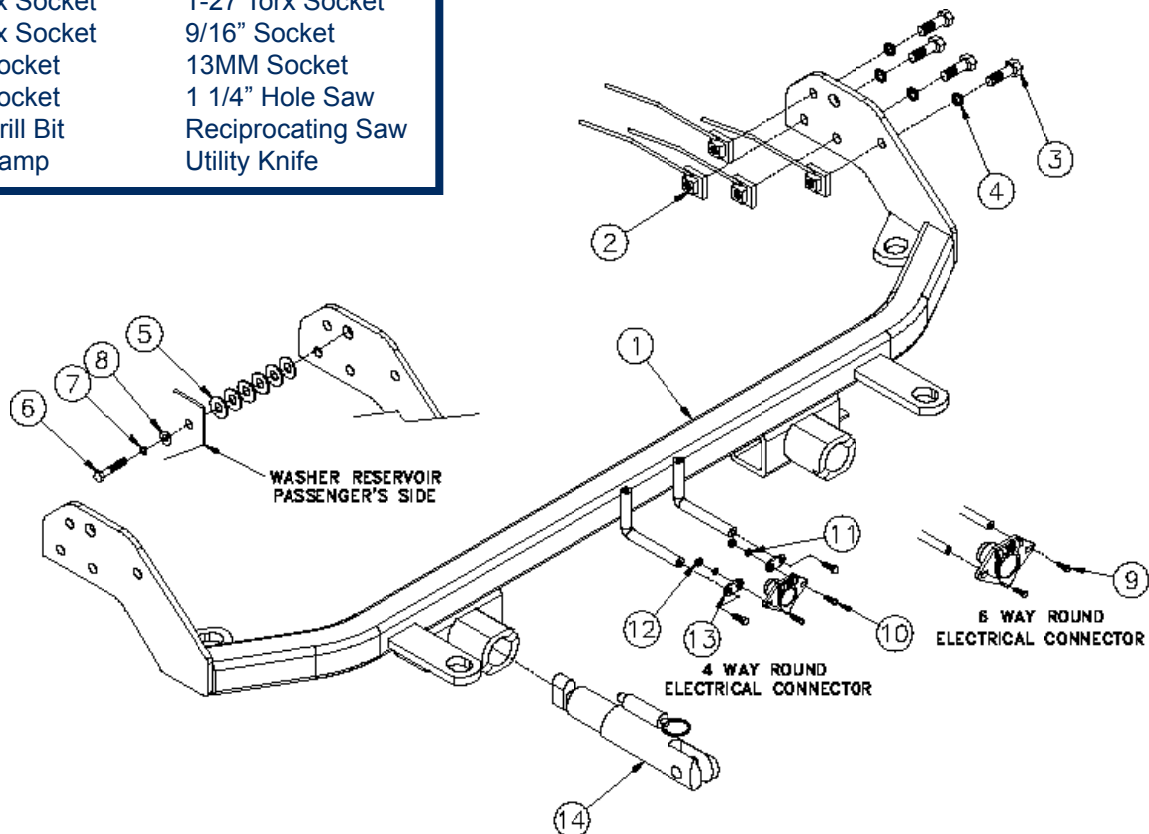

### Important:

Use only genuine factory replacement parts on your baseplate. Do **NOT** substitute homemade or non-typical parts. If a bolt is lost or in need of replacement, for your safety and the preservation of your baseplate, be sure to use a replacement bolt of the same grade (In most cases it will be Grade 5, please reference the parts list above). Replacement parts may be ordered through your nearest Blue Ox® Dealer or Distributor, or call our 24/7 Customer Care Team at (402)385-3051.

# BX3826

2007-09 VW Rabbit 2.5 w/out foglights

## Installation Instructions

### Attachment Tabs:

Motorhome mount tow bars are recommended for use with this baseplate. Due to the design of the removable tabs, the RangeFinderII, Adventurer, and Ambassador tow bars can not be used. The Acclaim tow bar may be used, but will not fold and store on the front of the vehicle. Adapters, except the Bx8833 and BX88151, can not be used with this baseplate.

### Instructions:

The front fascia, headlight assemblies, hood latch, horn bracket, turbo cooler, air dam, and metal bumper, are removed and reinstalled. Trimming of belly pan and front grille style is required.

The dimensional variations between otherwise identical vehicles can be considerable. While the baseplate was designed for easy installation, it may be necessary to tailor the baseplate slightly to compensate for auto manufacturer's tolerances. These minor adjustments may include filing a hole slightly, bending electrical rods, and/ or bending end plates.

The Bx8848 4 Diode Wiring Kit is recommended for this vehicle.



1. To remove the front fascia, start by removing a torx head bolt using a T25 Torx socket, then pushing a small clip (off set circle) to release the top of the fascia cover using a flat screwdriver. Do this to both sides of the vehicle and set aside bolts and top edge of fascia cover for later reinstallation.

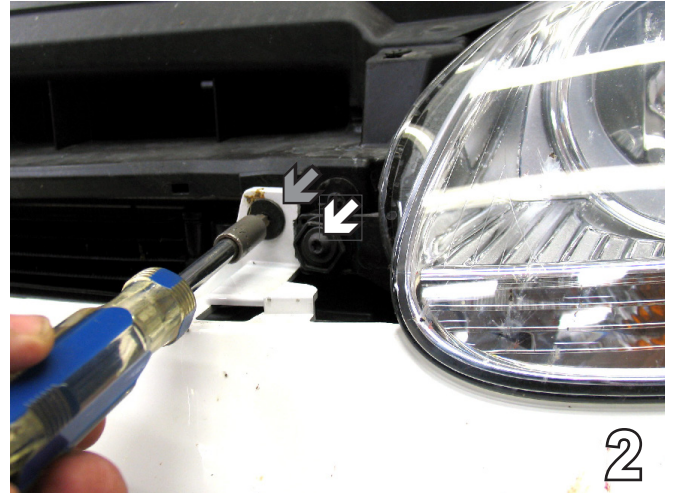

2. After removing the top part of the fascia, there are two other Torx bolts to remove using a T-27 Torx socket. Do this to both sides. Set bolts aside for later reinstallation.

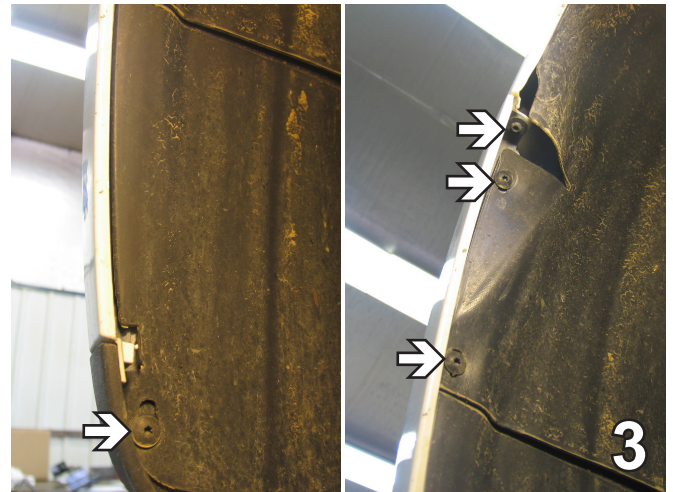

3. In the wheel well, just forward the front tire, remove four Torx bolts using a T-25 Torx socket. Do this to both sides and set aside for later reinstallation.



4. Under the fascia are eight Torx bolts that need to be removed with a T-25 Torx socket. Remove bolts and set aside for later reinstallation.

# BX3826

## 2007-09 VW Rabbit 2.5 w/out foglights Installation Instructions

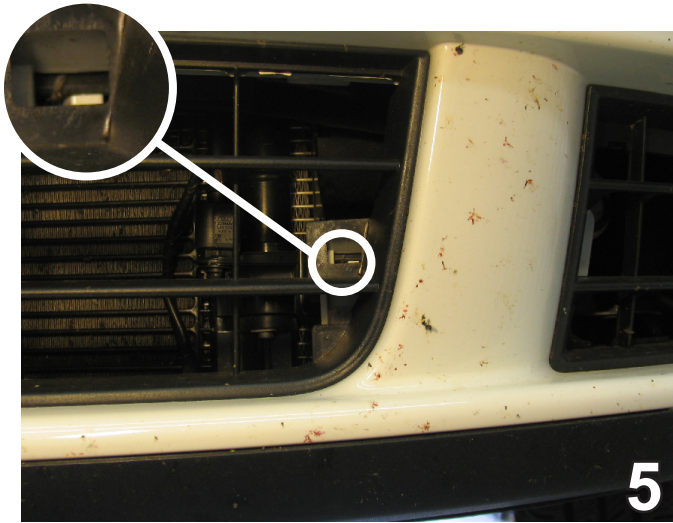

5. On the front of the fascia there is a small plastic clip (offset circle) to release the fascia. Push clips up to release by using a flat screwdriver. Do to both sides. Pull fascia corners out to the side then all fascia forward and set aside for later reinstallation.

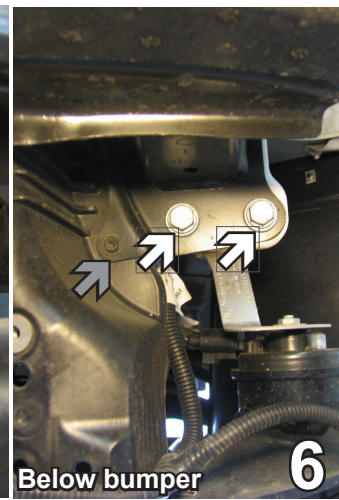
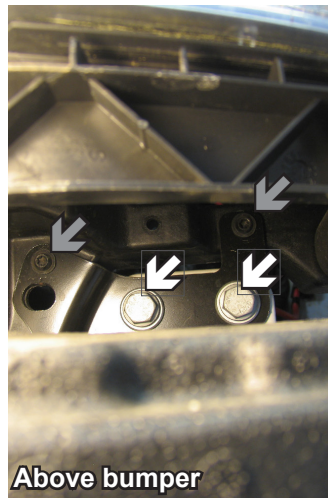

6. To begin removing bumper, remove two bolts (white arrows) with a 16MM socket, and also remove two torx head bolts (gray arrows) using a T-30 Torx socket. Do this to both sides and set aside to reinstall later.

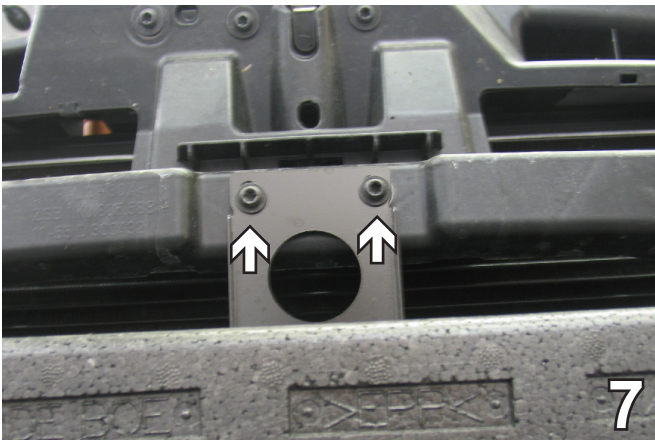

7. In the center of the metal bumper are two torx bolts that need to be removed using a T30 Torx socket. Remove bolts and bumper, set aside to reinstall later.

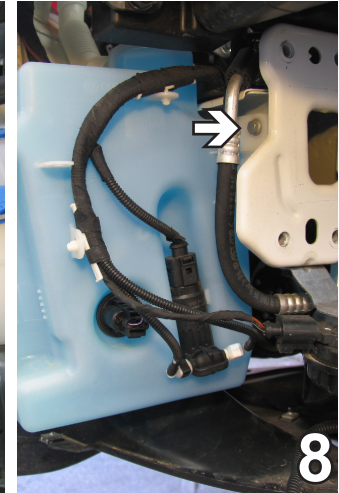
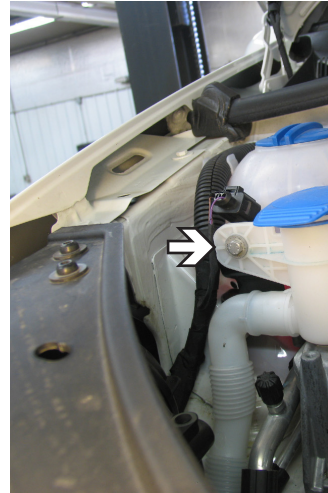

8. Using a 10MM socket, remove a hex bolt from the water reservoir inside the motor compartment and one bolt from the bottom of the water reservoir connecting it to the bumper. Set aside to reinstall later.

Disconnect fluid lines and electrical plugs as shown in step 8.

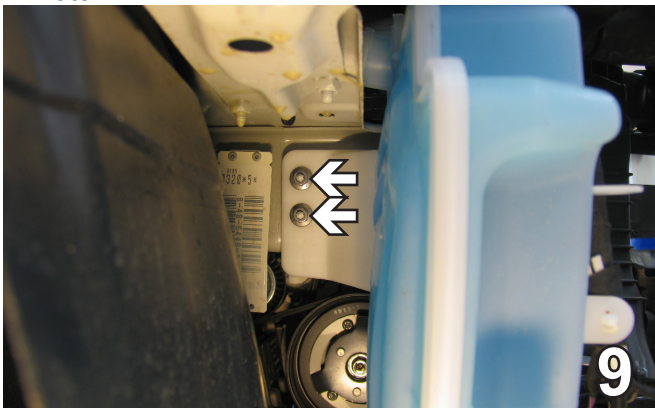

9. Behind the water reservoir, there are two hex bolts to be removed with a 10MM socket. Remove bolts and reservoir aside for reinstallation later.

# BX3826

## 2007-09 VW Rabbit 2.5 w/out foglights Installation Instructions

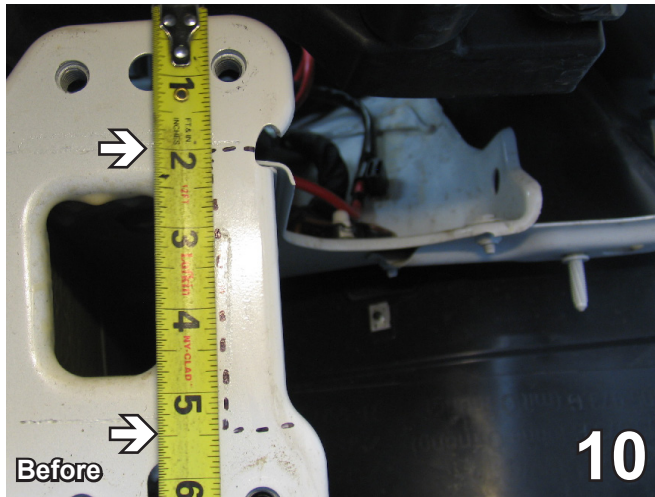

10. Measure from the top edge of frame end down and mark 2" and 5 1/2" on the side of frame webbing, both sides. Using the reciprocating saw, cut the webbing to the side of frame rail and make a vertical cut flush with the side of frame between the first two cuts.

**Using a good quality paint, spray cut edges of frame to prevent rusting.**

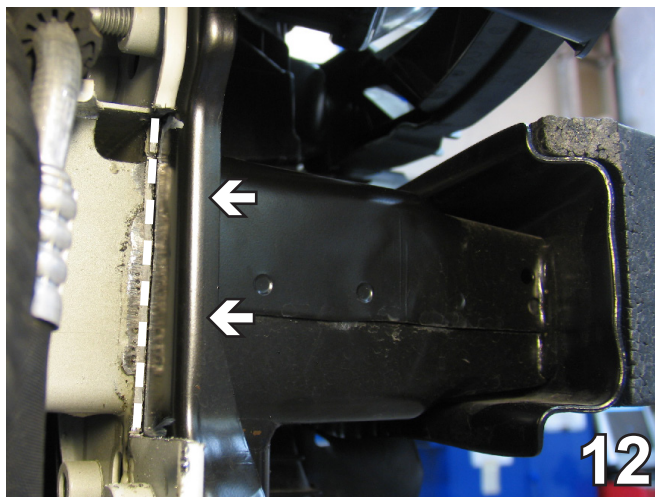

12. Reinstall metal bumper and mark the back of bumper bracket equal to the area removed in step 10 (passengers side shown.) Do this to both sides. Remove metal bumper and cut out affected areas and reinstall metal bump. Paint all cut areas to prevent corrosion.

14. Measure 3 1/2" in and 1 1/2" down (centered) off both ends of the metal bumper. Drill a hole using a 1 1/4" hole saw. Do to both sides of bumper.

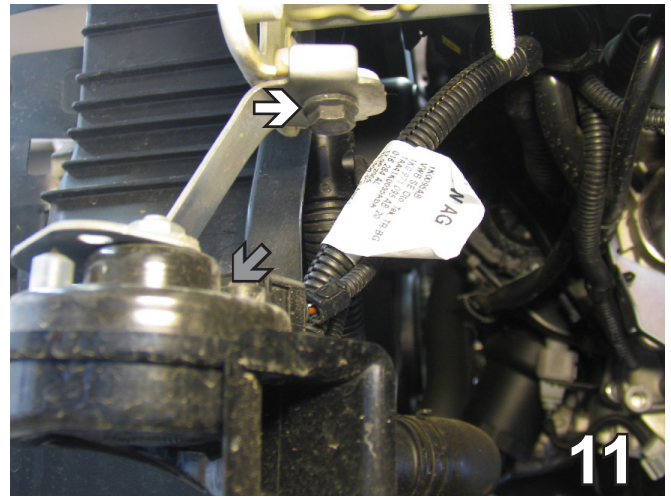

11. Remove the horn (gray arrow) from the vehicle to make installation of baseplate smoother by removing the bolt (white arrow) connecting it with a 13MM socket from both sides. Set bolts and horn aside for later reinstallation.

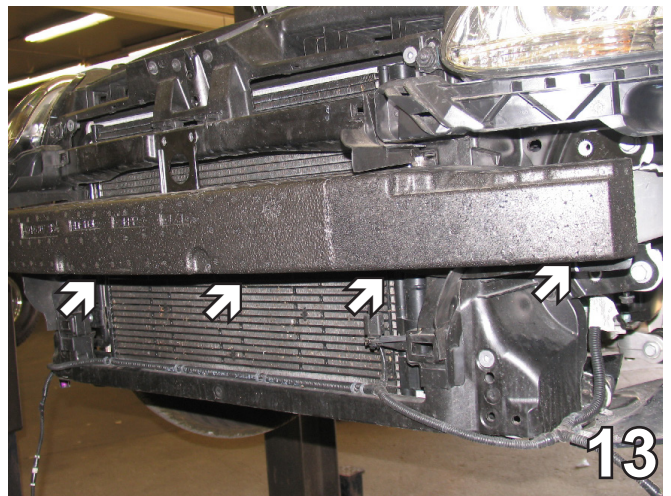

13. Remove the glued styrofoam carefully from the metal bumper and set aside for later reinstallation.

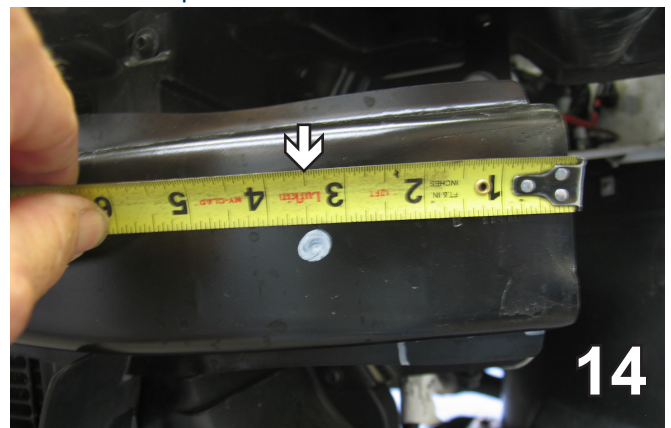

# BX3826

2007-09 VW Rabbit 2.5 w/out foglights

## Installation Instructions

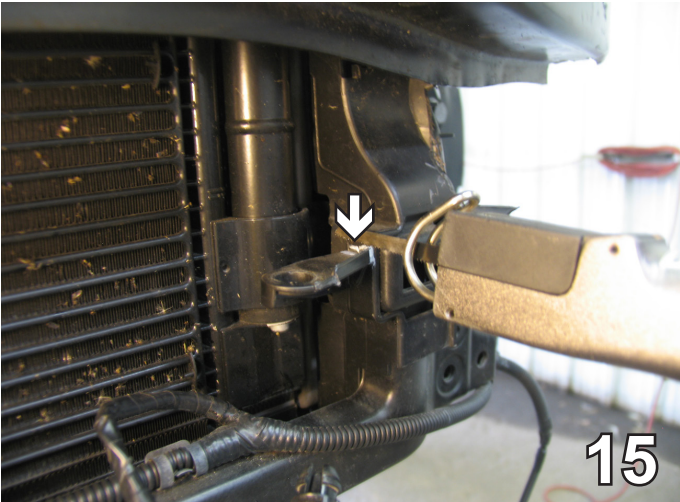

15. Remove temporary sensor, mark and cut the tab holding a sensor with a reciprocating saw. **Be careful not to cut into the radiator.** This sensor will be mounted on the baseplate itself later.

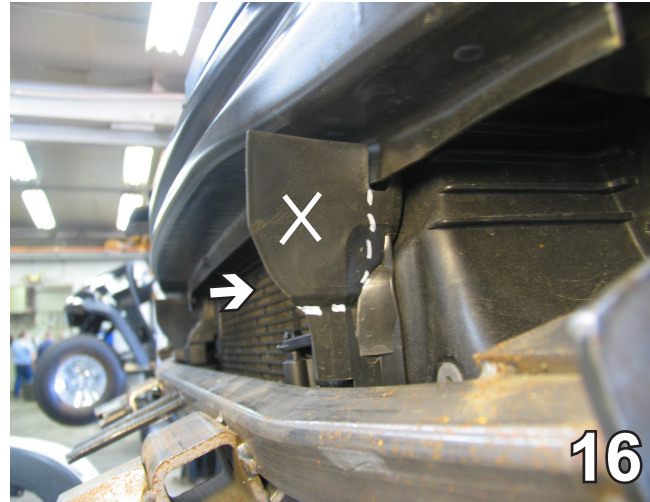

16. Above photo indicates how the cut should look like for the air dam before installing the baseplate.

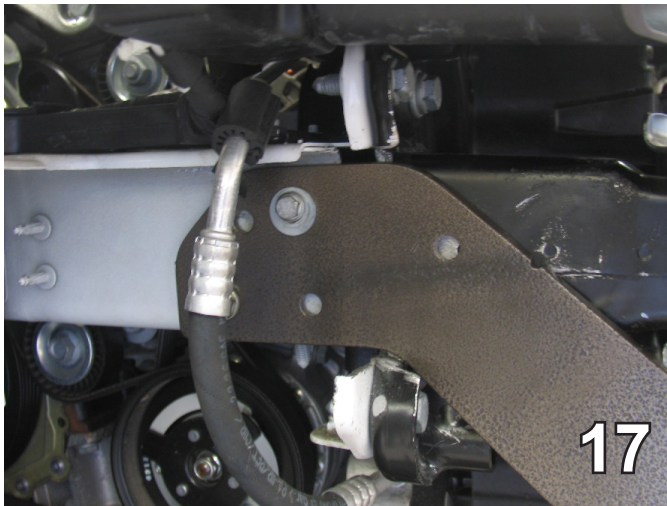

17. Slide and align the baseplate back onto the frame rail. Slide the baseplate up and in with the nose facing downwards. Align the baseplate with the back existing hole on the passenger side trying to center the holes as much as possible with the baseplate.



18. Level the baseplate on the driver's side and clamp in place. Using a 13/32" drill bit, drill the top back hole. Install the 3/8" hex bolt and lock washer with the 3/8" nut plate inserted into the frame end.

19. Using the baseplate as a template, drill the remaining holes using a 13/32" drill bit. Be sure that attachment tabs are level with vehicle.

Insert nut plates into 1 1/4" hole on bumper (gray arrow) to align with drilled holes of baseplate, tighten 3/8-16 bolts and lock washers. Do this to both sides.

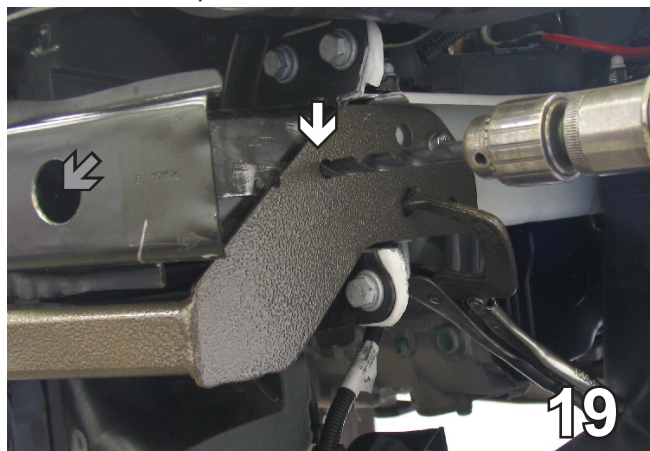

# BX3826

## 2007-09 VW Rabbit 2.5 w/out foglights Installation Instructions

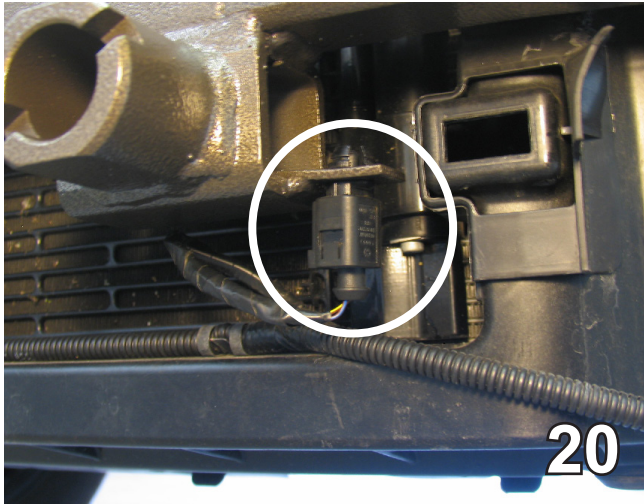

20. Reinstall the sensor to the clip on the baseplate next to the removable tab insert.

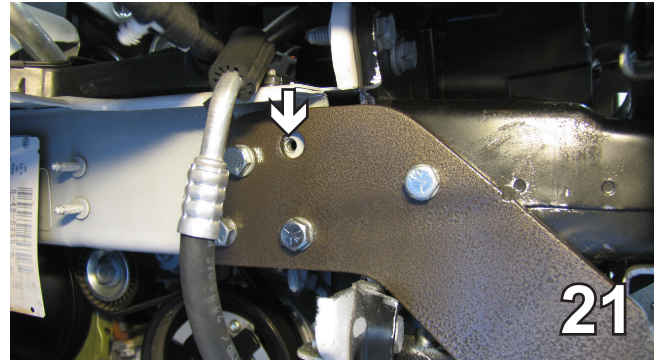

21. Remove bolt on the passenger side of the baseplate from step 18.

**\*\*BE SURE TO USE LOCTITE® RED ON ALL BOLTS BEFORE TIGHTENING. TIGHTEN ALL BOLTS ACCORDING TO THE TORQUE CHART ON PAGE 1 OF THESE INSTRUCTIONS OR ON PAGE 3 OF THE BASEPLATE TOWING GENERAL INSTRUCTIONS.**

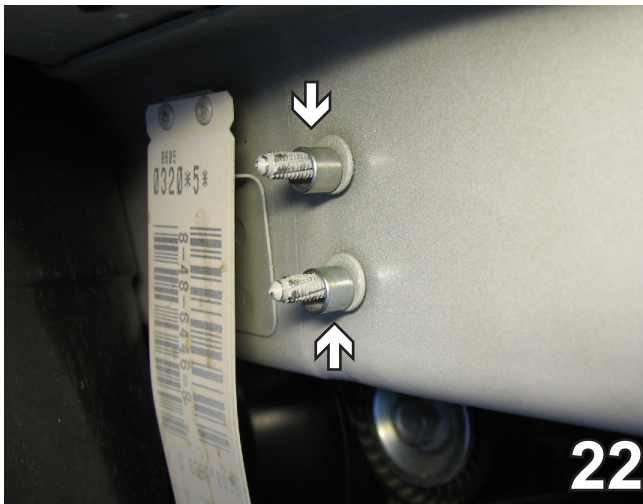

22. When reinstalling the water reservoir, there are 1/2" spacer for the reservoir. NOTE: These washers easily slide off, be sure to keep them on.



23. Using a 6MM hex bolt lock and flat washer. Install the six 3/8" lock washers between the reservoir and baseplate, then tighten water reservoir to its original location.

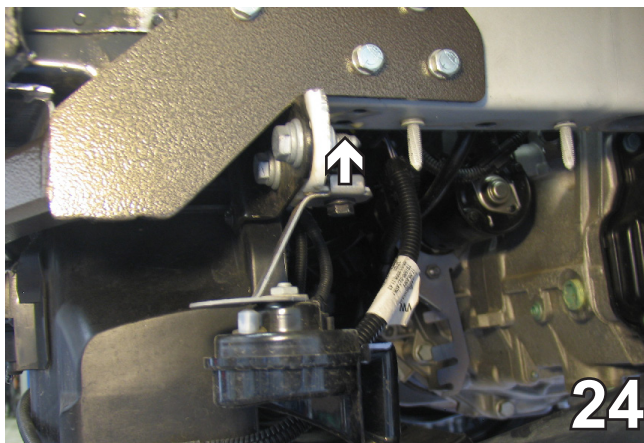

24. Reinstall both horns and brackets using existing bolts. Reinstall styrofoam on metal bumper.

# BX3826

2007-09 VW Rabbit 2.5 w/out foglights

## Installation Instructions

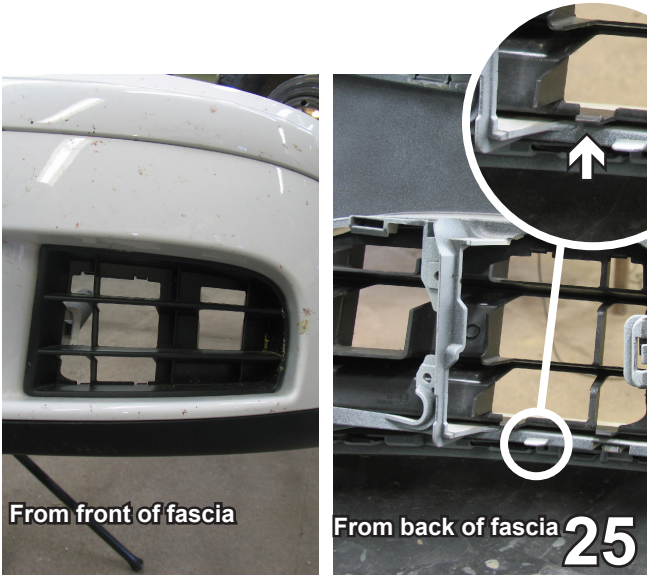

25. On the fascia, remove the black plastic webbing insert on the drivers side. From the backside of the fascia, remove the webbing by releasing the clip (inset circle). This will be reinstalled later, set aside.

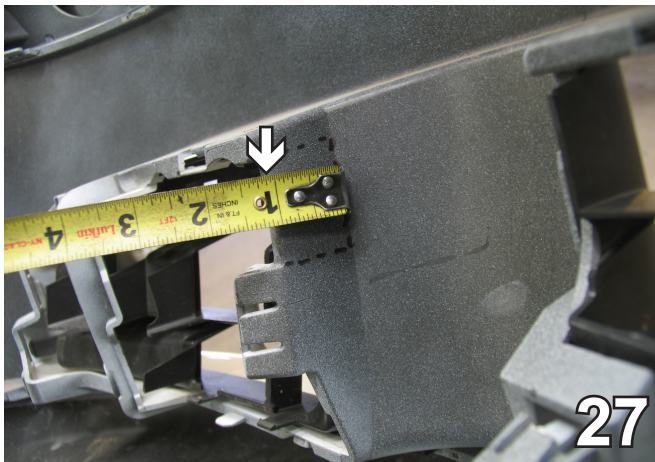

27. On the backside of the fascia, measure and mark 1" to a 1 1/8" down to the crease in fascia existing loop then trim. Do this to both sides. Reinstall fascia.

29. Replace black plastic webbing as close to its original position as possible. On the drivers side, trim around the baseplate to make webbing fit and snap back into place. The installation of the baseplate is complete.

Install the tow bar and safety cables according to the instructions when demonstrating this to the customer. Be sure to include all the contents and packages.

Do **NOT** substitute other devices if the tow bar pins and clips are misplaced.

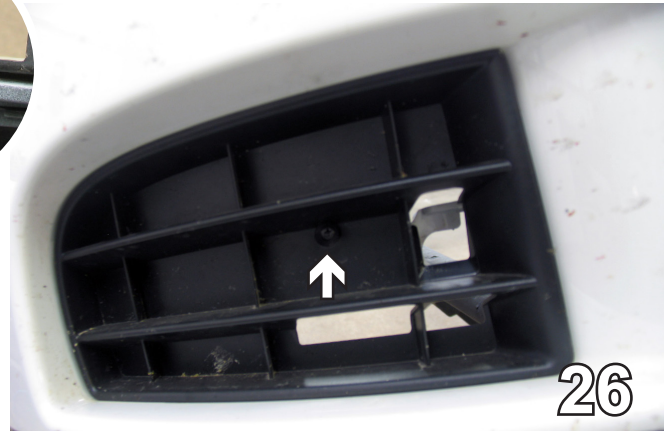

26. On the passenger side of the fascia, remove the plastic black webbing insert. Using a Phillips screwdriver, remove the single screw holding the webbing in place and set aside. Set webbing and screw aside for later reinstallation.



28. Replace black plastic webbing insert as close to its original position as possible. On the passenger side, trim around the baseplate to make insert fit (white arrow). Replace the screw (gray arrow) just below original location to hold the webbing in place.





# BX3826

2007-09 VW Rabbit 2.5 w/out foglights

## Installation Instructions

**Be sure that ALL electrical connections are plugged in properly and functioning BEFORE installing the fascia.**

**DEALER or INSTALLER:**

**Be certain the user receives the instruction sheets for their products.**



**Without removable tabs installed.**



**With removable tabs installed.**

## Customer Service Commitment

Blue Ox is committed to providing you with exceptional customer care throughout your lifetime with our products. Our team is here to assist you with any questions you may have regarding the performance of your product. Simply call 1-800-228-9289 and you can speak with our customer care team.

Additionally, please visit our website to see which rallies our Destination America team will be attending. For a nominal fee, our service technician will service your towing system to ensure it's in proper working condition. Also as a commitment to our customers, should you visit our factory you can stay at our full service Blue Ox campground at no charge along with enjoying a factory tour.

Again thank you for being our customer and for the confidence you have shown in the performance of our products. It is because of customers like you we enjoy the success we have today.



© 2005, 2006 Blue Ox  
One Mill Road, Industrial Park  
Pender, Nebraska 68047  
Phone: (402) 385-3051  
Toll Free: (888) 425-5382  
Fax: (402) 385-3360  
[www.blueox.us](http://www.blueox.us)

# General Information

1. Ensure that your product(s) are registered online at [www.blueox.com](http://www.blueox.com). It is crucial to register your product(s) so that you may be alerted of product offerings, updates, upgrades, maintenance and safety bulletins, and/or recalls.
2. **It is the owner's responsibility to inspect all towing equipment for cracked welds, missing or worn parts and loose bolts before each towing trip.** Be sure to use Loctite® Red on all bolts and tighten to the recommended specifications.
3. **It is the owner's responsibility to hook up all towing equipment per manufacturer's instructions/recommendations.**
4. Remove the attachment tabs when not in use (if applicable).

## Notice To Baseplate Installer

### 1. It is YOUR responsibility to watch for:

- Oil cooler and air conditioner lines
- Electrical wires and hoses
- Missing parts or attaching points on the frame

\*\* If the baseplate is improperly installed and is against a wire or hose, it could cause fluid leaks or electrical shorts some time after the actual baseplate installation.

## Permanent Baseplate Safety Cable Installation

Permanent baseplate safety cables are strongly recommended when towing a vehicle with a tow bar. The principle function of the permanent baseplate safety cables is to prevent the towed vehicle from breaking loose in the event the connection between the frame of the towed vehicle and the baseplate fails or becomes disconnected. The cables must be connected from the baseplate to the frame rail or cross member of the vehicle's frame. The illustrations below show the possible arrangements recommended by Blue Ox®. Each permanent baseplate safety cable must have an adequate weight rating for the towing system. The weight rating of the two (2) cables together will not qualify.

***Do not mount the permanent baseplate safety cables against wires, hoses or brake lines.***

These permanent baseplate safety cables should remain installed as long as the baseplate is installed on the vehicle. Permanent baseplate safety cables are to be used in conjunction with, and NOT a replacement for legally required safety cables attaching the towed vehicle to the towing vehicle.

### OPTION #1

Permanent Baseplate Safety Cables to Cross Member or Frame of Towed Vehicle.

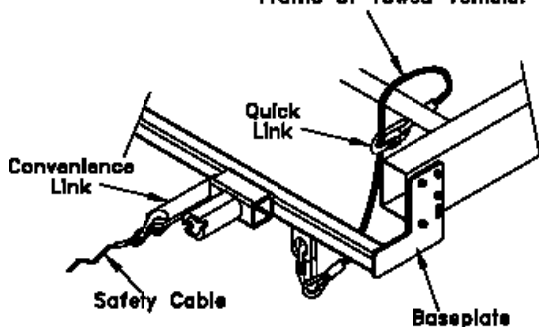

### OPTION #2

Permanent Baseplate Safety Cables to Cross Member or Frame of Towed Vehicle.

