



BX3332

2008-10 Saturn Vue and Redline 2012-15 Chevy Captiva (All Models) Installation Instructions

Attachment Tab Height: 21-1/2"

Attachment Tab Width: 18-1/2"

Serial Number

Please read BOTH these Installation Instructions and the General Information sheet prior to installing or operating this equipment.

- Blue Ox® towing products and accessories are intended to be installed by Blue Ox® Dealers who are familiar with our products and have the equipment and knowledge necessary to do "fit work". If needed, Blue Ox® Dealers can be found at www.blueox.com or by contacting our Technical Service Department at (402) 385-3051.
- Many Blue Ox® baseplates are designed to use existing holes and hardware to mount the baseplate to the towed vehicle. Even though bolts are there, do not assume they are adequate for baseplate mounting. Always use the hardware supplied in the hardware kit and existing hardware as specified in the installation instructions.

Bolt Torque Specifications		
Torque in Foot-Pounds for Inch Bolts		
Bolt Size	Grade 5	Grade 8
1/4"	10	14
5/16"	19	29
3/8"	33	47
7/16"	54	78
1/2"	78	119
5/8"	154	230
3/4"	257	380

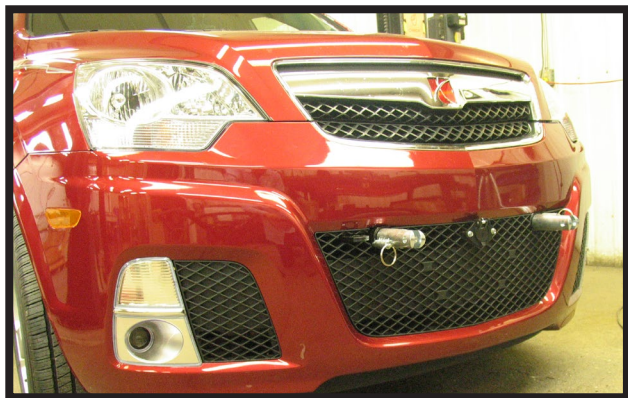

If the front of your vehicle looks different than this, please contact us at (402)385-3051.

Bolt Torque Specifications		
Torque in Foot-Pounds for Metric Bolts		
Bolt Size	Grade 8.8	Grade 10.9
6MM	6	8
8MM	16	22
10MM	31	40
12MM	54	70
14MM	89	117
16MM	161	230
18MM	222	318

WARNING

Failure to read and follow these instructions could result in separation of the towed vehicle from the tow bar, causing property damage, loss of towed vehicle, personal injury or death.

Reference your vehicle owner's manual for manufacturer's towing specifications.

BX3332
2008-10 Saturn Vue and Redline
2012-15 Chevy Captiva (All Models)
Installation Instructions

Instruction Notes: The fascia, hood latch, air baffle, air dams, windshield washer fluid reservoir and (if equipped) coolant lines are removed and reinstalled for the baseplate installation. Some drilling and trimming is required.

Place all components that are removed on a flat, sturdy surface. All items will be reinstalled unless otherwise noted after the baseplate is installed.

The dimensional variations between otherwise identical vehicles can be considerable. While the baseplate was designed for easy installation, it may be necessary to tailor the baseplate slightly to compensate for vehicle manufacturer's tolerances.

The BX8869 Tail Light Wiring Kit is recommended for this vehicle.



Drill a hole according to the tail
light wiring kit instructions.

NOTICE

- Handling of some cosmetic parts when installing this product may require the use of protective covers, rags, specialty tools, etc. to prevent damage.
- When using power drills be aware of the dangers of torque and drill bit length.
- When using a reciprocating saw be aware of objects behind the cutting surface.
- Use a good quality paint to spray cut edges of frame to prevent rusting.
- Be sure that **ALL** electrical connections are plugged in and accessories are functioning properly before reinstalling the fascia.
- The baseplate is computer tested to your vehicle's GVWR, exceeding this weight will void the manufacturer's warranty.
- Be sure to use a sufficient amount of Loctite® Red on all bolt threads before tightening. Tighten all bolts according to the torque chart provided unless otherwise specified.
- Dealer or installer be certain the user receives these instruction sheets.
- If the baseplate is in an accident, it must be replaced. **DO NOT** use it again! An accident can cause unseen damage and using it again could result in more damage or serious injury. **DO NOT** use the baseplate if it is damaged or missing parts.

BX3332
2008-10 Saturn Vue and Redline
2012-15 Chevy Captiva (All Models)
Installation Instructions

Tools Required

Large Vise Grip
 Reciprocating Saw
 Utility Knife
 Phillips Screwdriver
 Torque Wrench
 Drill
 Tape Measure
 Loctite® RED
 13/32" Drill Bit
 1-1/4" Hole Saw
 7MM Socket
 10MM Socket
 12MM Socket
 9/16" Socket
 9/16" Wrench

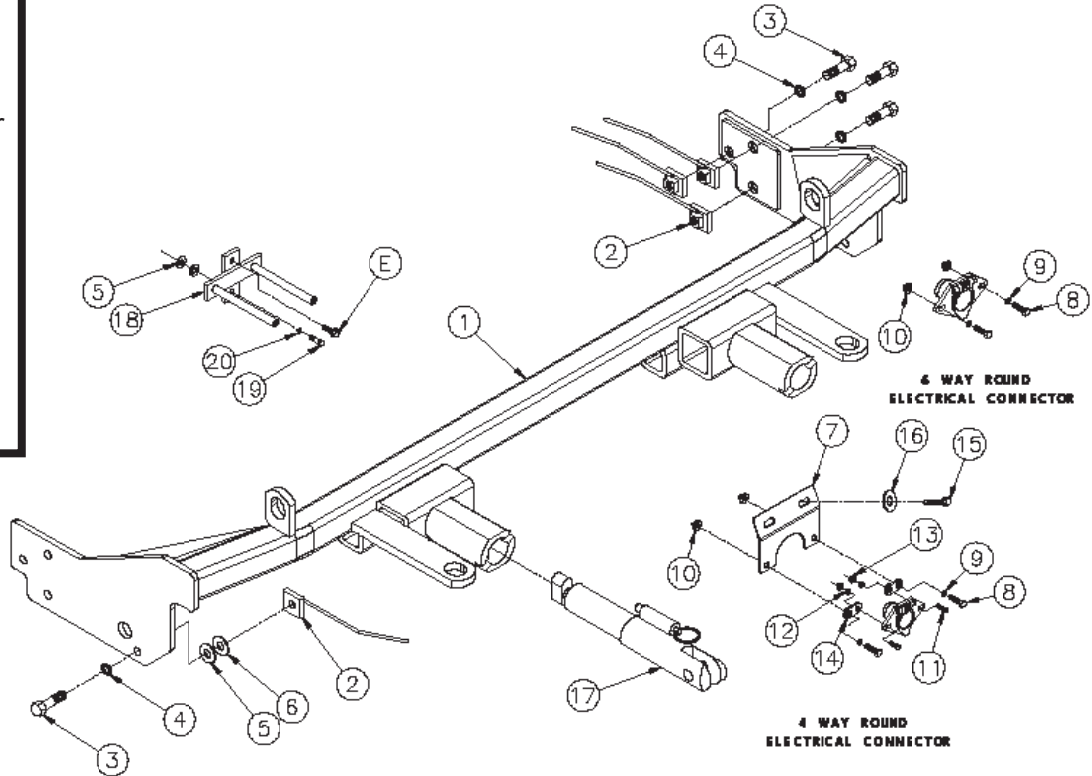

Item No.	Part No.	Description	Qty.
1.....	61-6416.....	BX3332 Baseplate.....	1
2.....	61-5208.....	3/8"-16 Nut Plate w/ Wire.....	8
3.....	201-0440.....	3/8"-16 x 1-1/2" Hex Head Bolt, Grade 5, ZP.....	8
4.....	203-0010.....	3/8" Lock Washer, ZP.....	8
5.....	203-0002.....	5/16" Flat Washer, ZP.....	6
6.....	203-0003.....	3/8" Flat Washer, ZP.....	4
7.....	101-6645.....	Electrical Bracket, 20 Degree.....	1
8.....	201-0050.....	1/4"-20 x 3/4" Hex Head Bolt, Grade 5, ZP.....	3
9.....	203-0008.....	1/4" Lock Washer, ZP.....	2
10.....	202-0069.....	1/4" Hex Flange Whiz Nut, ZP.....	2
11.....	201-0192.....	#10-32 x 1/2" Slotted Round Head Screw.....	2
12.....	203-0054.....	#10 Lock Washer.....	2
13.....	202-0047.....	#10-32 Hex Nut.....	2
14.....	101-5822.....	4 Way Adapter Connector.....	2
15.....	201-0654.....	#10-16 Self Drilling Screw, ZP.....	2
16.....	203-0001.....	1/4" Flat Washer, ZP.....	3
17.....	62-3469.....	Attachment Tab Assembly.....	2
18.....	61-6493.....	TT Frame Bracket.....	1
19.....	201-0655.....	6MM-1.0 x 30MM Hex Head Bolt, Grade 8.8, ZP.....	1
20.....	203-0161.....	6MM Lock Washer, ZP.....	1
21.....	226-0046(not shown).....	Class III Safety Cables.....	2
22.....	229-0359(not shown).....	3/8" Quicklink, ZP.....	4
23.....	290-0437(not shown).....	Black Cap Plug Receiver.....	2
24.....	201-0979(not shown).....	#12-14 x 1" Self Drilling Screw, ZP.....	2
25.....	202-0102(not shown).....	1/4"-20 Hex Nylon Nut, ZP.....	1
E.....		Existing Bolt.....	1

BX3332
2008-10 Saturn Vue and Redline
2012-15 Chevy Captiva (All Models)
Installation Instructions

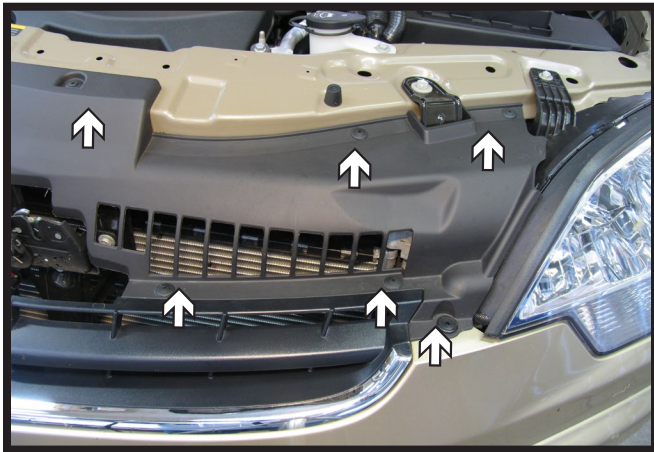

1. Using a phillips screwdriver, remove eleven (11) pushpins from the fascia cover. There are six (6) on the driver side and five (5) on the passenger side.

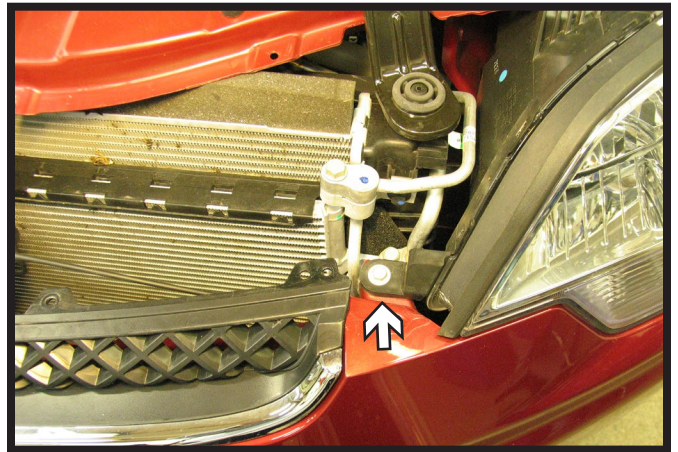

2. Using a 10MM socket, remove bolt on top edge of fascia. Do this both sides.

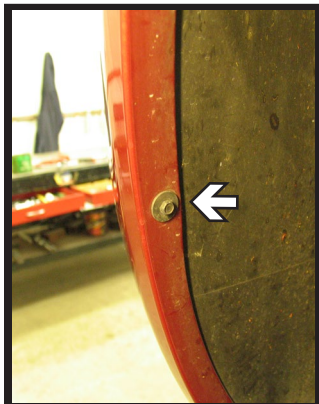

3. Using a 7MM socket, remove the screw just forward the front tire (left) and the screw from the fascia joint (right). Do this to both sides of the vehicle.

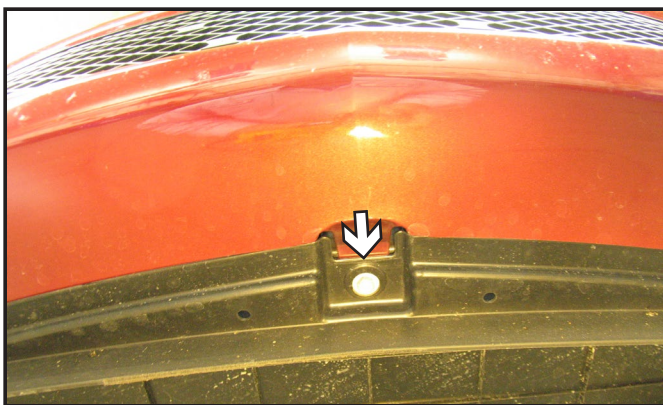

4. Using a 10MM socket, remove the screw directly below the license plate on the fascia. Further underneath are three (3) pushpins to remove.

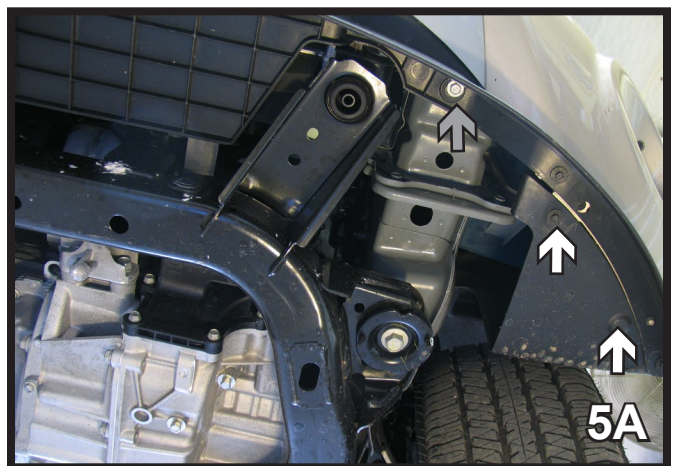

5. VUE/CAPTIVA MODELS
Just forward the front tire, underneath the fascia, use a 7MM socket to remove two (2) screws (white). Using a 10MM socket, remove one screw (gray) as shown. Do this to both sides of the vehicle.

BX3332
 2008-10 Saturn Vue and Redline
 2012-15 Chevy Captiva (All Models)
 Installation Instructions

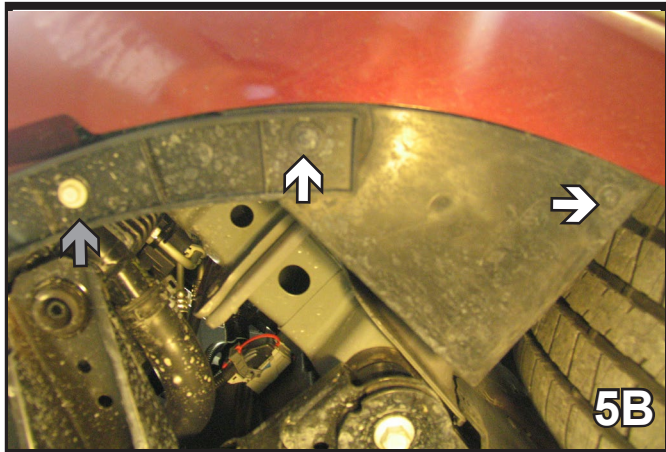

5. REDLINE MODEL
 On the underside of the fascia, using a 7MM socket, remove two (2) screws (white). Using a 10MM socket, remove one screw (gray). Do this to both sides of the vehicle.

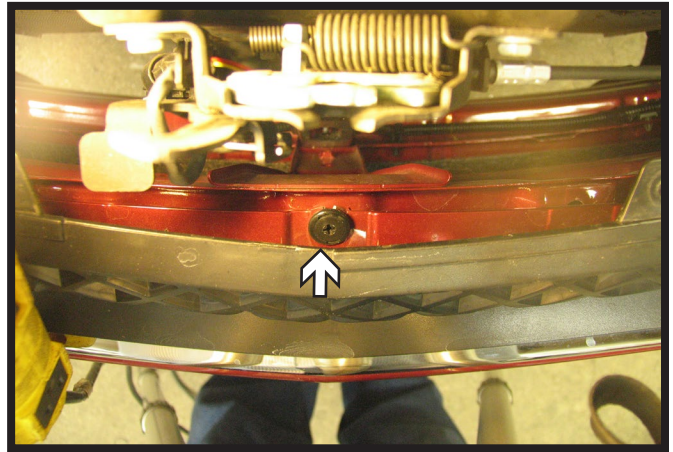

6. Straight down in front of the latch and just behind upper grille, using a phillips screwdriver, remove the black push pin. Pull fascia corners out to the side of vehicle, both sides, then pull fascia forward and set aside carefully.

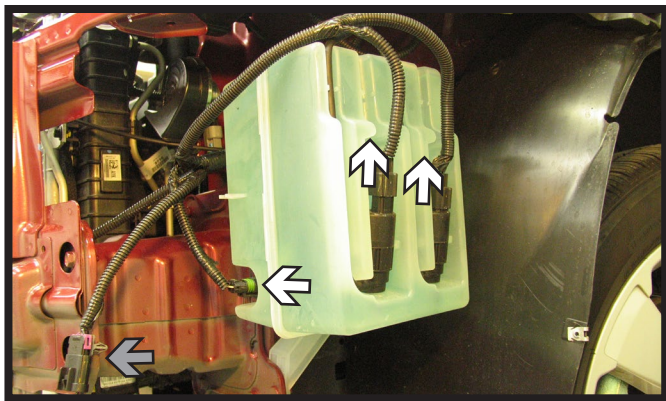

7. On the driver side, disconnect all hoses and electrical connections from the washer reservoir. Also unplug the one main plug in the front (gray arrow).

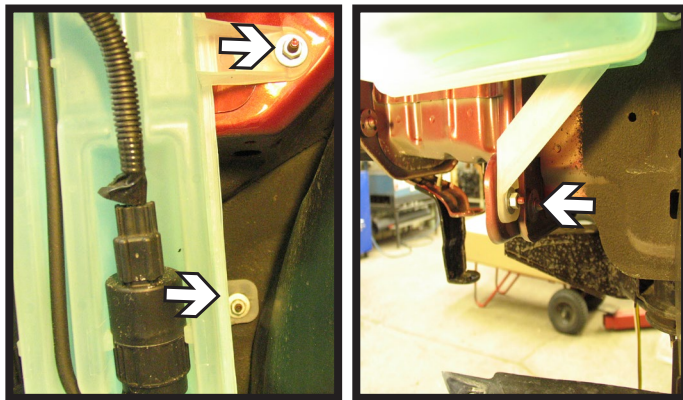

8. Using a 10MM socket, remove two (2) bolts just forward the front tire (8A) and the lower bolt (8B) to remove the washer reservoir.

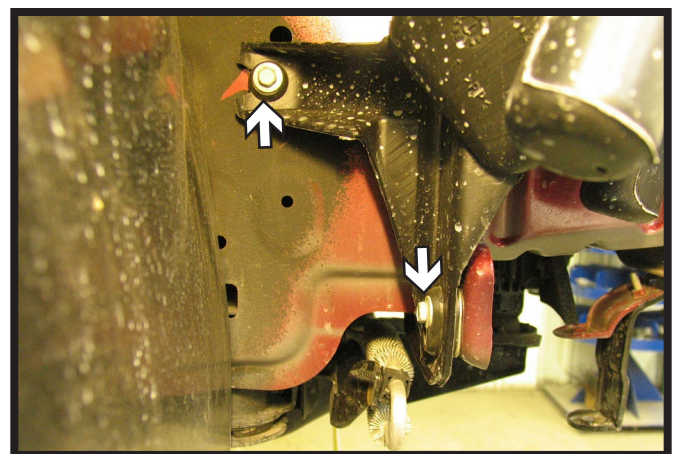

9. On the passenger side, using a 10MM socket, remove the two (2) bolts from the air baffle.

BX3332
2008-10 Saturn Vue and Redline
2012-15 Chevy Captiva (All Models)
Installation Instructions

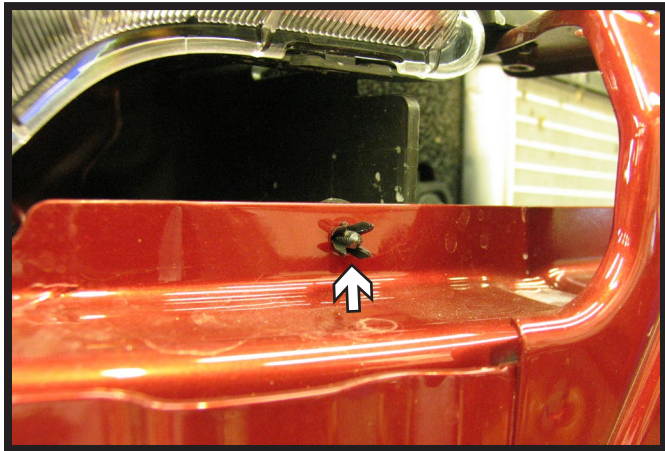

10. On the passenger side only, remove the push pin that is on the backside of bumper, just below the headlight, by pushing the center piece out.

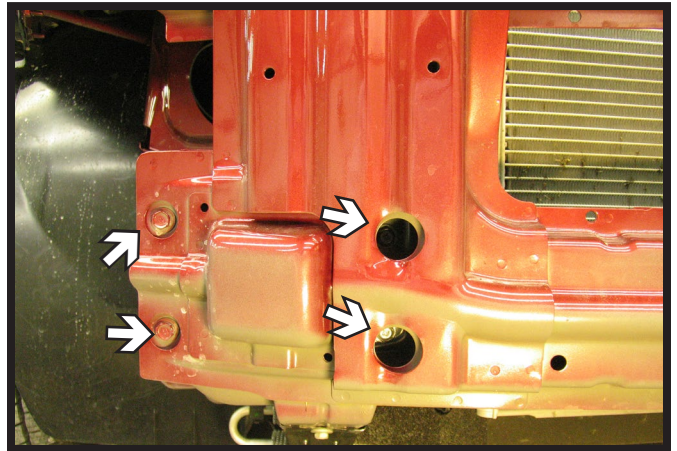

11. Remove four (4) bolts using a 12MM socket. Do this to both sides of the vehicle. Set aside metal bumper for later reinstallation.

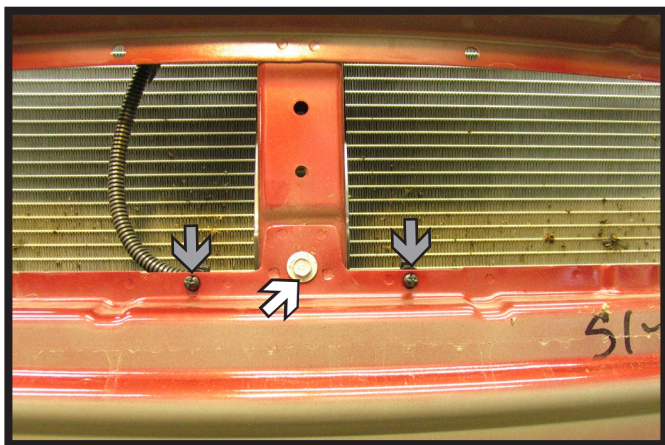

12. Using a 10MM socket, remove one (1) bolt from the center of metal H-frame bumper. Also remove two (2) pushpins located behind metal piece (gray arrows) from the wire harness (left).

If equipped, unistall the coolant line bolts and push pins on the front of the vehicle and from the passenger side (below). Carefully move the coolant line aside for baseplate installation.

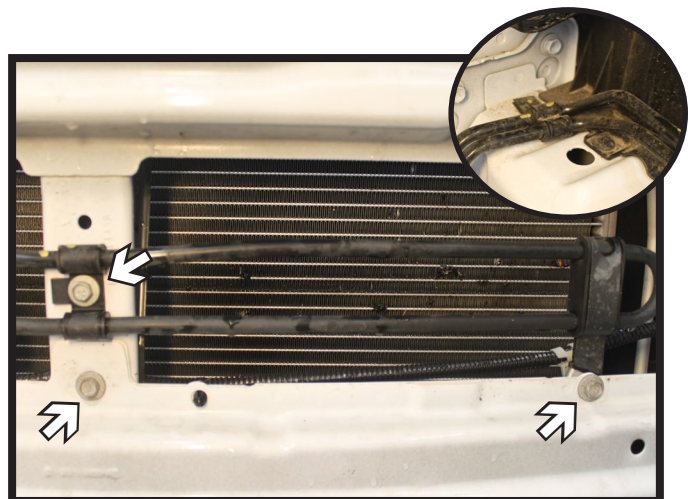
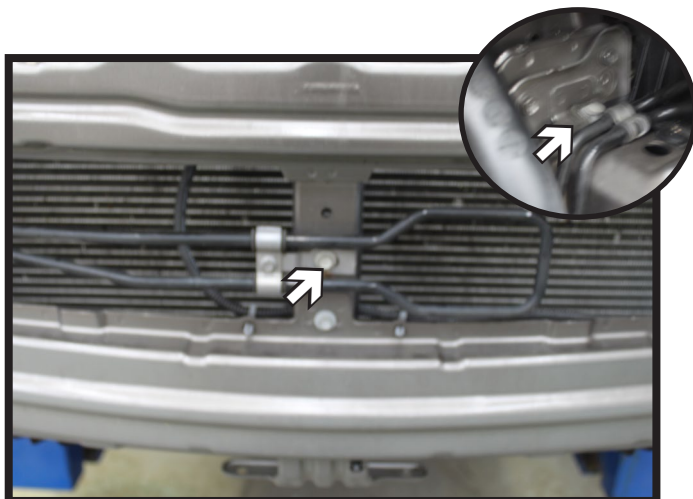

BX3332
2008-10 Saturn Vue and Redline
2012-15 Chevy Captiva (All Models)
Installation Instructions

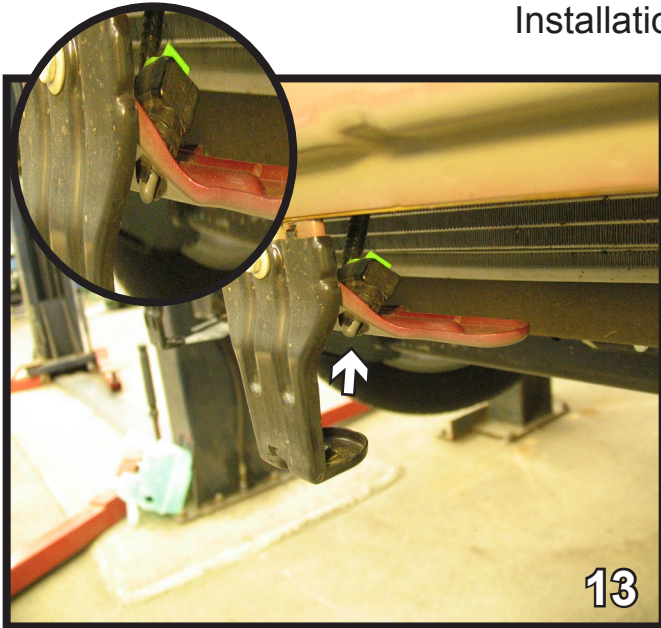

13. In the center of the metal bumper is a temperature sensor that needs to be removed. Depress clips on the front side of bracket and push the sensor back and set up out of the way. This will all be reinstalled in the same place later. Pull H-Frame bumper forward to release.



14. On the passenger side, remove the push pin from the top of the air dam. Do this to both sides.

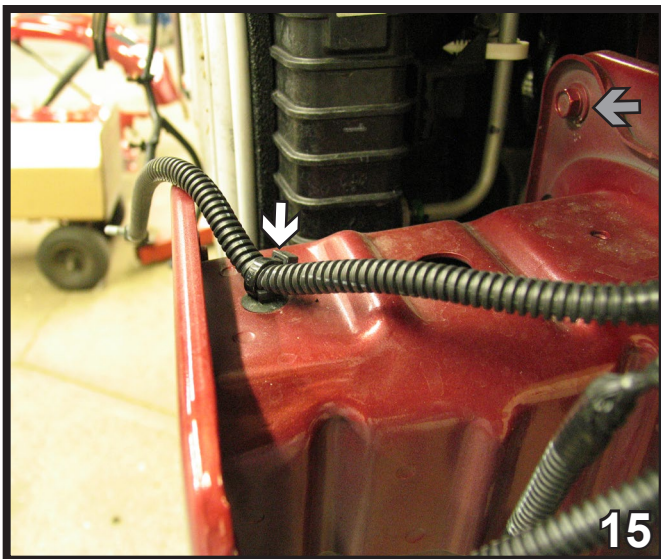

15. On the driver's side, remove the Christmas tree pin holding the wire loom. Pull wire loom out of the way.

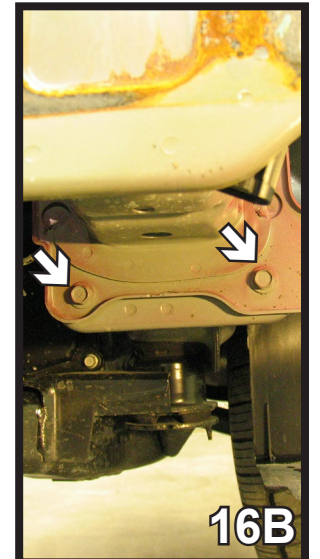
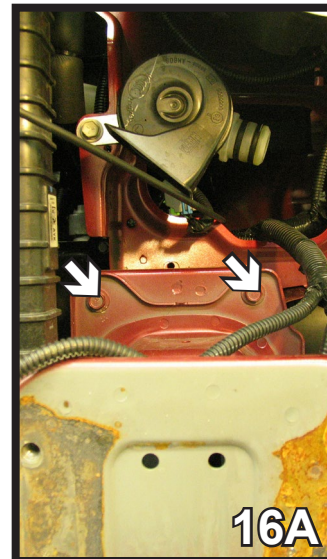

16. To remove frame extension, remove four (4) bolts, two (2) on top (16A), two (2) on bottom (16B), using a 12MM socket. Do this to both sides.

BX3332
2008-10 Saturn Vue and Redline
2012-15 Chevy Captiva (All Models)
Installation Instructions

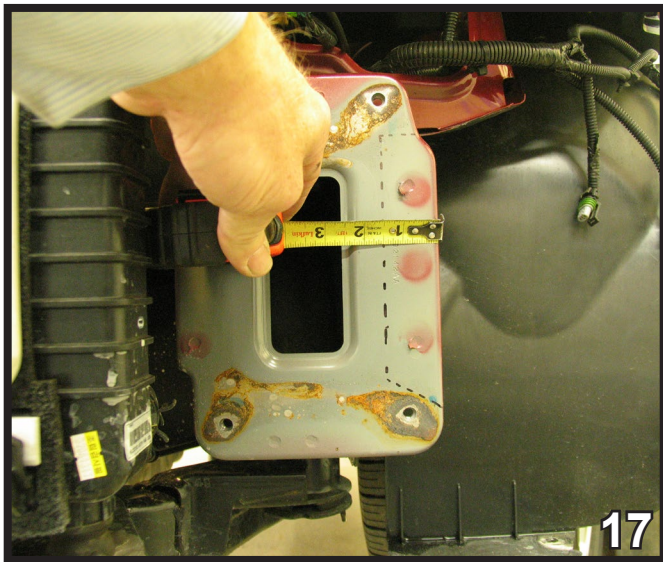

17. Measure and mark on the side of frame end 1-1/2" wide. Do this to both sides.
**NOTE: 1-1/2" measurement may vary depending on the model of vehicle and is intended to be flush with side of the frame (see photo in Step 19).

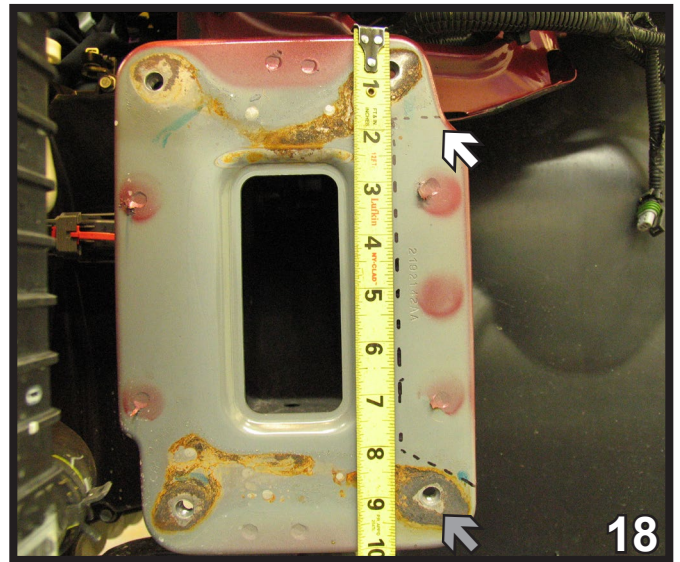

18. Using a reciprocating saw, start a horizontal cut flush with the frame 1-3/4" down from the top and go down to 8" then down at an angle to miss the bolt hole (see gray arrow). Do this to both sides.

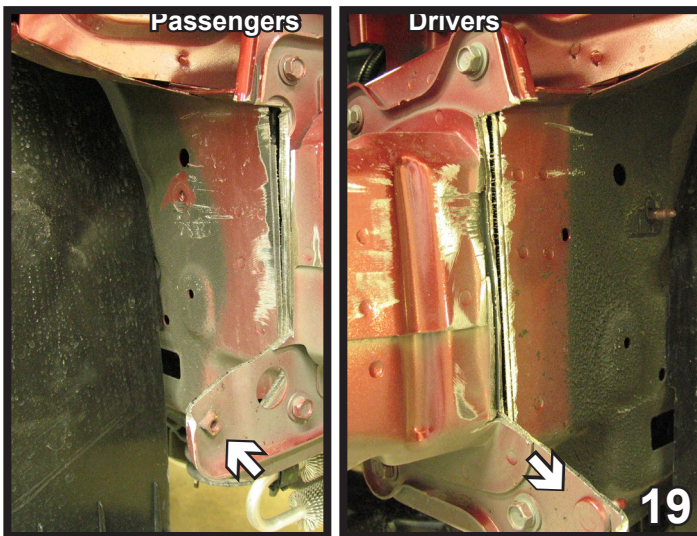

19. Reinstall frame extension, mark and remove same area as step 18 with reciprocating saw. The photos show the extensions after completion. It may be necessary to remove the extensions to cut them. NOTE, leave the weld nut on the passenger's side, and the threaded stud for the water reservoir on the to be reinstalled on the driver's side. Reinstall the passenger's side frame extension. The driver's side will be reinstalled later.

BX3332
2008-10 Saturn Vue and Redline
2012-15 Chevy Captiva (All Models)
Installation Instructions



20. With a 1-1/4" hole saw, drill a hole into the center of the indent on the frame extension to set wire nut for baseplate installation. Do this to both sides.

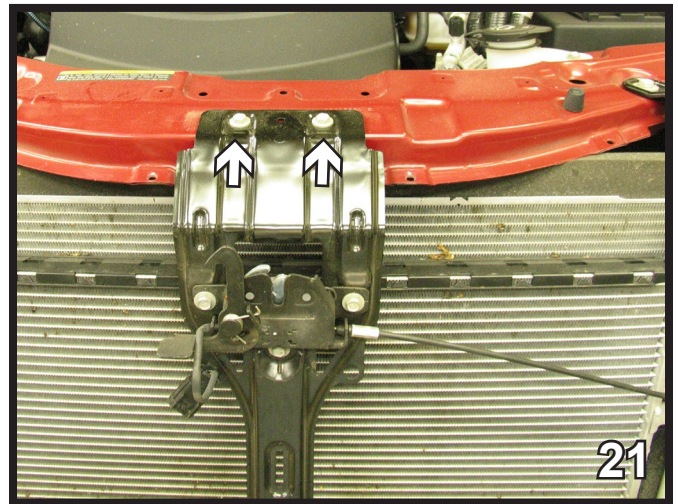

21. Remove two (2) bolts holding hood latch in with a 10MM socket. Set aside for later reinstallation BEFORE bumper bracket.

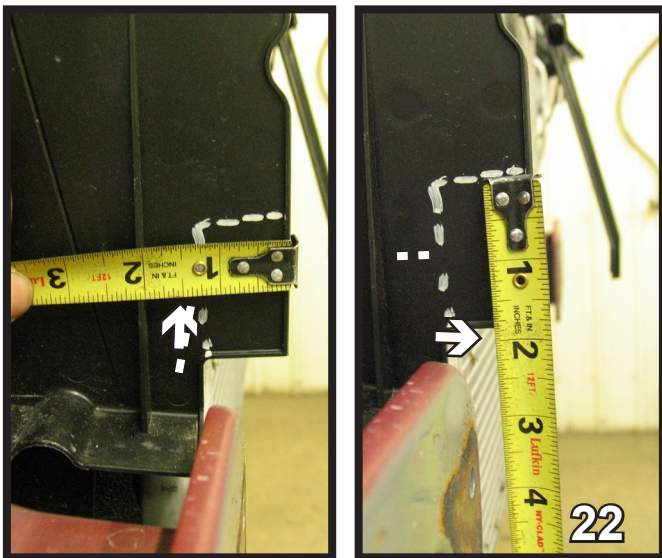

22. With a utility knife, trim the air dam 1-1/2" wide by 2" tall. This is done only on the passengers side.

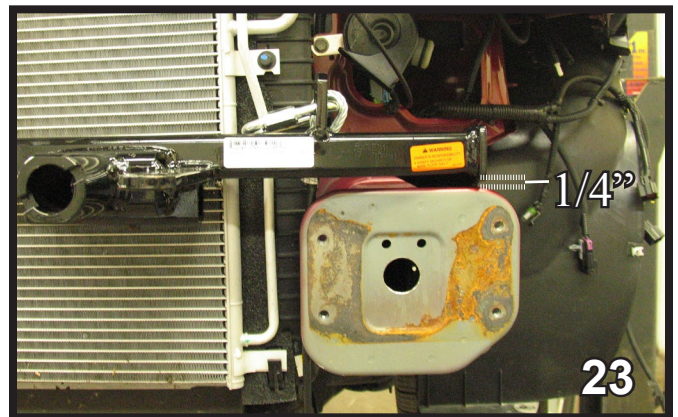

23. Reinstall driver's side frame extension while sliding baseplate onto frame end, then reinstall extension. Clamp and align lower edge of baseplate flush with ridge on side of extension and 1/4" above top ridge of frame extension (see photos in steps 24 and 25 for correct placement). Align large hole on passenger side with existing large hole on frame extension and adjust driver side an equal distance forward. Using the baseplate as a template drill all holes into frame and extension with 13/32" drill bit. Do this to both sides.

BX3332
2008-10 Saturn Vue and Redline
2012-15 Chevy Captiva (All Models)
Installation Instructions

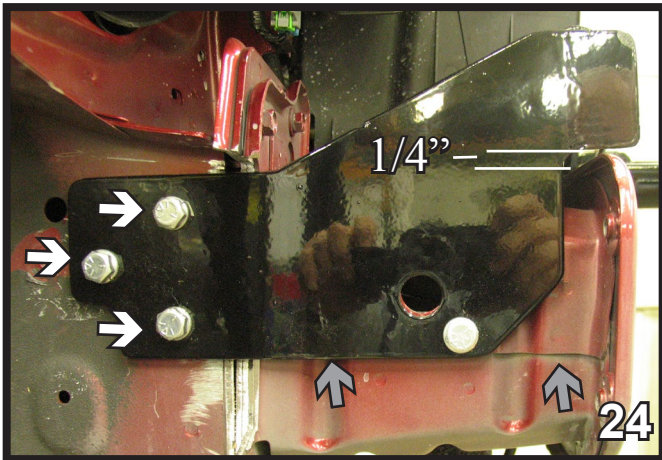

24. Be sure that the baseplate is level with the frame extension ridge before tightening (see gray arrows). Insert nut plates into frame extension end and align with baseplate holes, install all 3/8-16 x 1 1/2" hex bolts with 3/8" lock washers into nut plates and tighten down. Do this to both sides.

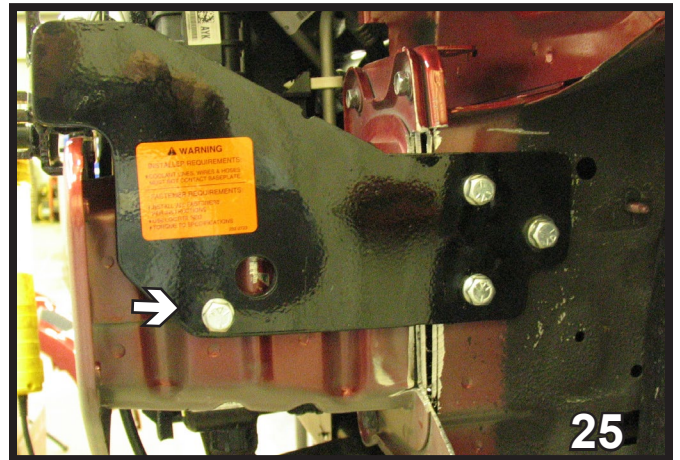

25. Place two 5/16" or 3/8" flat washers between the baseplate and extension as needed to fill gap, then insert a 3/8"-16 x 1-1/2" hex bolt and 3/8" lock washer, tighten into nut plate.

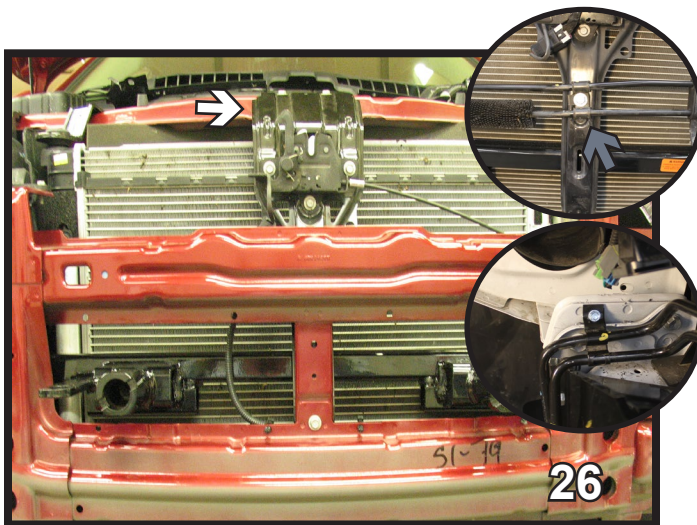

26. Reinstall hood latch assembly and metal bumper by using existing holes and bolts. NOTE: If equipped with coolant lines, reinstall it into the existing hole as shown (inset) before bumper reinstallation, using the supplied 1/4" hardware (gray). Reconnect the coolant line on the passenger side using the supplied self tapping screw.

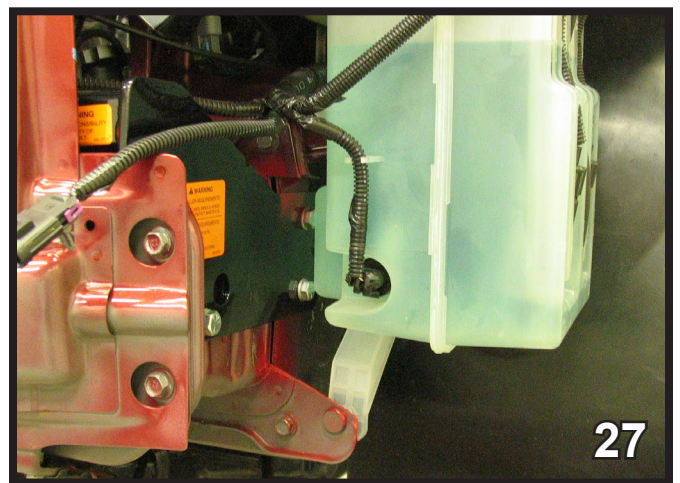

27. Reinstall the washer reservoir with the existing bolts, clip fluid and electrical lines back into place.

BX3332
2008-10 Saturn Vue and Redline
2012-15 Chevy Captiva (All Models)
Installation Instructions



28. Reattach air baffle with existing holes and existing bolts.

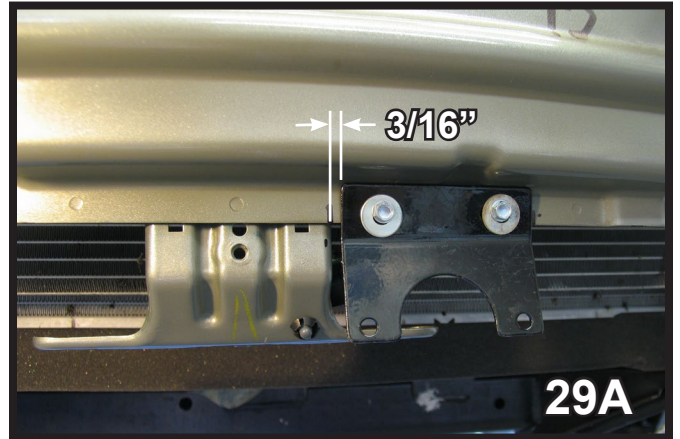

29. VUE / CAPTIVA MODELS

Keeping a 3/16" gap to the right of the center on the lower metal bumper support, place the connector as high as you can on the webbing and install with #10-16 self-drilling screws and 1/4" flat washers.

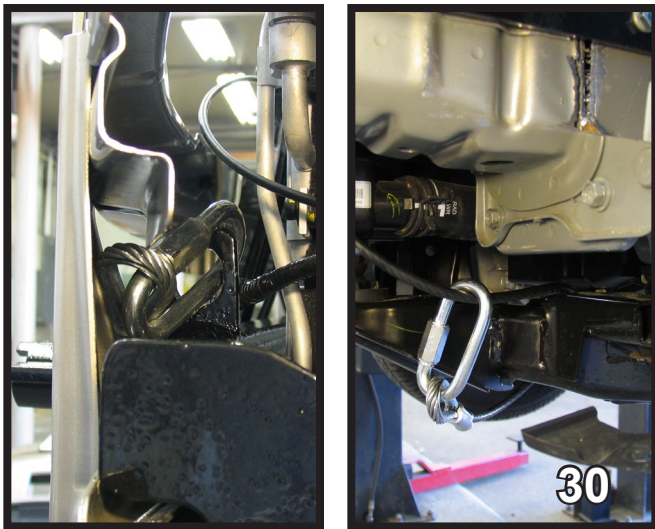

30. Attach the permanent baseplate safety cables to the provided convenience link on the baseplate. The photo above shows the recommended installation of the cables to frame of vehicle. Additional options may interfere with suggested mounting; in this case secure the cables to a solid piece of the frame as described in the instructions included with the permanent baseplate safety cables. Be sure the safety cables do not rub against any hoses or moving parts. Do this to both sides of the vehicle.

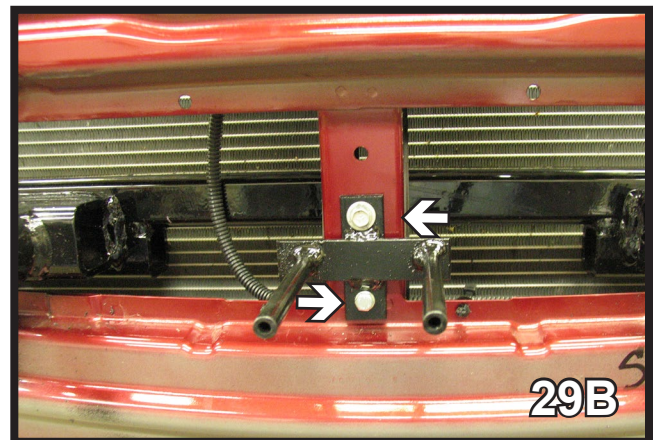

29. REDLINE MODEL

Use the existing bolt in the top hole of the connector and install with 6MM x 30MM hex bolt and 6MM lock washers with two (2) 5/16" washers behind to get the bracket flush.

BX3332
2008-10 Saturn Vue and Redline
2012-15 Chevy Captiva (All Models)
Installation Instructions

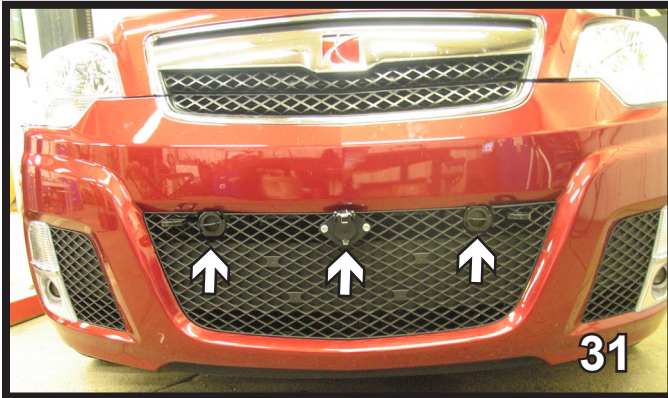

31. REDLINE MODEL

Hold fascia as close to it's original position as possible, trim grille opening as needed. Reinstall fascia, then install connector plug using appropriate hardware for either a 4-way connector plug or 6-way connector plug.



32. VUE/CAPTIVA MODELS

Hold fascia as close to it's original position as possible, trim grille opening as needed. Reinstall fascia, then install connector plug using appropriate hardware for either a 4-way connector plug or 6-way connector plug.

CUSTOMER SERVICE COMMITMENT

Blue Ox® is committed to providing you with exceptional customer care throughout your lifetime with our products. Our team is here to assist you with any questions you may have regarding the performance of your product. Simply call (402) 385-3051 and you can speak with our technical service team.

Additionally, please visit our website to see which rallies our Destination America team will be attending. For a nominal fee, our service technician will service your towing system to ensure it's in proper working condition. Also, as a commitment to our customers, should you visit our factory, you can stay at our full service Blue Ox® campground at no charge along with enjoying a factory tour.

Again, thank you for being our customer and for the confidence you have shown in the performance of our products. It is because of customers like you we enjoy the success we have today.

© 2016 Blue Ox
One Mill Road, Industrial Park
Pender, Nebraska 68047
Phone: (402) 385-3051
Fax: (402) 385-3360
www.blueox.com

General Information

1. Ensure that your product(s) are registered online at www.blueox.com. It is crucial to register your product(s) so that you may be alerted of product offerings, updates, upgrades, maintenance and safety bulletins, and/or recalls.
2. **It is the owner's responsibility to inspect all towing equipment for cracked welds, missing or worn parts and loose bolts before each towing trip.** Be sure to use Loctite® Red on all bolts and tighten to the recommended specifications.
3. **It is the owner's responsibility to hook up all towing equipment per manufacturer's instructions/recommendations.**
4. Remove the attachment tabs when not in use (if applicable).

Notice To Baseplate Installer

1. It is YOUR responsibility to watch for:

- Oil cooler and air conditioner lines
- Electrical wires and hoses
- Missing parts or attaching points on the frame

** If the baseplate is improperly installed and is against a wire or hose, it could cause fluid leaks or electrical shorts some time after the actual baseplate installation.

Permanent Baseplate Safety Cable Installation

Permanent baseplate safety cables are strongly recommended when towing a vehicle with a tow bar. The principle function of the permanent baseplate safety cables is to prevent the towed vehicle from breaking loose in the event the connection between the frame of the towed vehicle and the baseplate fails or becomes disconnected. The cables must be connected from the baseplate to the frame rail or cross member of the vehicle's frame. The illustrations below show the possible arrangements recommended by Blue Ox®. Each permanent baseplate safety cable must have an adequate weight rating for the towing system. The weight rating of the two (2) cables together will not qualify.

Do not mount the permanent baseplate safety cables against wires, hoses or brake lines.

These permanent baseplate safety cables should remain installed as long as the baseplate is installed on the vehicle. Permanent baseplate safety cables are to be used in conjunction with, and NOT a replacement for legally required safety cables attaching the towed vehicle to the towing vehicle.

Option #1

(Baseplates with Convenience Link Tabs)

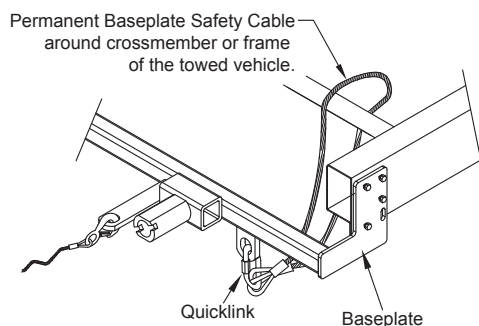

Option #2

(Baseplates with out Convenience Link Tabs)

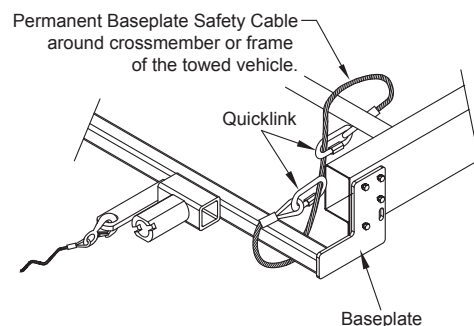

BLUE OX ORIGINAL PURCHASERS THREE YEAR LIMITED WARRANTY

Automatic Equipment Manufacturing Company ("Automatic") warrants to the original (first) retail purchaser that this product, manufactured by Automatic, shall be free from defect in material and workmanship under normal use and service for a period of three years from the date of delivery.

During said three-year period, Automatic will repair or replace any parts that have been returned by the original purchaser, to the factory, transportation prepaid, and in Automatic's sole and absolute opinion found to be defective.

Limitations on Warranty Coverage:

Coverage under this warranty will be valid only if the customer warranty card is returned by the original purchaser within 30 days of purchase.

Coverage under this warranty will be effective only when a copy of the original invoice, showing date and place of purchase, accompanies any claim for warranty. This warranty is NON TRANSFERABLE.

This limited warranty will not cover, in any way or form, any alleged damages caused by incorrect or improper installation, improper use, modification or neglect of product, failure to properly service and maintain, misuse, act of God, accident or failure of the user to follow guidelines contained in the instructional material provided by Automatic.

This warranty does not cover normal wear and tear, paint or rust.

Warrantor assumes no responsibility to the owner for loss of use of product, loss of time, inconvenience or any other damage consequential or otherwise. Including, but not limited to mileage, expense of transporting of product, return shipping expense, mechanics travel time, telephone, road service, towing, and rental during repairs, travel, lodging, loss or damage to personal property or loss of earnings.

REPAIR OR REPLACEMENT AS SET FORTH IN THIS LIMITED WARRANTY IS THE SOLE EXCLUSIVE REMEDY OF THE PURCHASER. AUTOMATIC SHALL NOT BE LIABLE FOR ANY INCIDENTAL OR CONSEQUENTIAL DAMAGES FOR BREACH OF ANY EXPRESS OR IMPLIED WARRANTY ON THIS PRODUCT. EXCEPT TO THE EXTENT PROHIBITED BY APPLICABLE LAW, ANY IMPLIED WARRANTY OF MERCHANTABILITY OR FITNESS FOR A PARTICULAR PURPOSE ON THIS PRODUCT IS LIMITED IN LENGTH TO THE DURATION OF THIS WARRANTY.

Please visit <http://blueox.com/warranty/> to register your warranty

